

# Thermal Overload Relays

# Electronic Overload Relays





## Contents

### **Thermal/electronic overload relays**

Overview .....	4
Motor protection .....	6

### **FieldBusPlug devices**

Motor protection .....	7
------------------------	---

### **Thermal overload relays**

Ordering details T, TA .....	8
Buttons and auxiliary contacts, functionality and data .....	11
Accessories for TA-relays .....	12

### **Electronic overload relays E16DU, UMC22-FBP**

Ordering details .....	14
------------------------	----

### **Electronic overload relays E200/320/500/800DU**

Ordering details .....	14
------------------------	----

### **Thermal overload relays T...**

Description .....	15
Technical data .....	18
Selection tables .....	23

### **Electronic overload relays E16DU...E800DU, UMC22-FBP**

Technical data .....	26
----------------------	----

### **Thermal/electronic overload relays, UMC22-FBP and Accessories**

Dimension diagrams .....	31
--------------------------	----

# Thermal overload relays TA... Electronic overload relays E... Overview

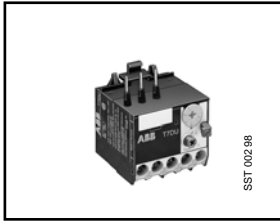
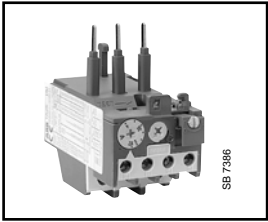
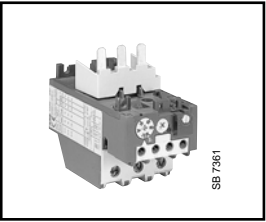
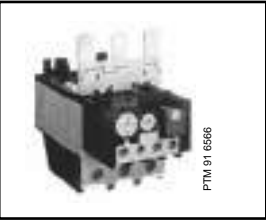

## Thermal Overload relays

				
Type	<b>T7DU</b>	<b>TA25DU</b>	<b>TA42DU</b>	<b>TA75DU</b>
Setting ranges	from 0.1 ... 0.16 A to 9.0 ... 12.0 A	from 0.1 ... 0.16 A to 24 ... 32 A	18 A 29 ... 42 A	18 A 60 ... 80 A
<b>Mounting possibilities onto contactor</b>				
Mounting onto	B6, VB6, VB6A, BC6, VBC6, VBC6A, B7, VB7, VB7A, BC7, VBC7, VBC7A	A9 ... A40 AE9 ... AE40 BC9 ... BC30 TBC9 ... TBC30	A30, A40 AE30, AE40	A50 ... A75 AF50 ... AF75 AE50 ... AE75 TAE50 ... TAE75
Mounting kit	no mounting kit required, direct mounting			
<b>Accessories</b>				
Remote tripping coil	–	DS25-A	–	–
Remote reset coil	–	DR25-A	–	–
Separate wall mounting kit	–	DB25	DB80	
<b>Thermal overload relays for special applications</b>				
For motors with heavy starting	–	–	–	–
For EEx e motor protection	–	TA25DU ... V1000	TA42DU ... V1000	TA75DU ... V1000

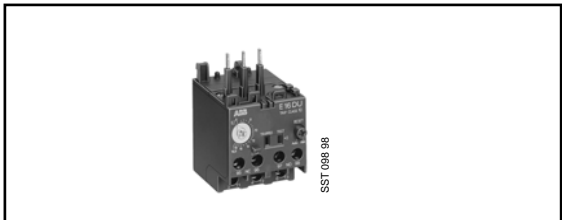
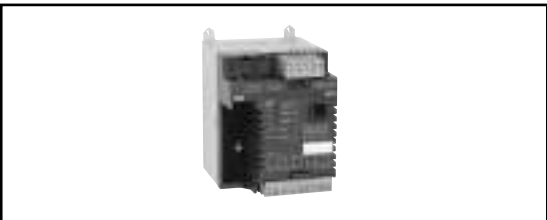
## Electronic Overload relays

		
Type	<b>E16DU</b>	<b>UMC22-FBP</b>
Setting ranges	from 0.1 ... 0.32 A to 5.7 ... 18.9 A	0.2 A 63 A
<b>Mounting possibilities onto contactor</b>		
Use with contactor sizes	B6,B7 A9...A16	A9...A75 bigger sizes with transformer
Mounting kit	no mounting kit required	
<b>Accessories</b>		
Main terminal shroud	terminal shroud integrated	
Separate mounting kit	DB16E	
<b>Electronic overload relays for special applications</b>		
For motors with heavy starting	class 10, 20, 30	class 5, 10, 20, 30 adjustable
EEx e motor protection	EEx e/ATEX	

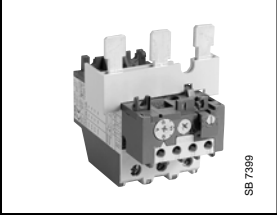
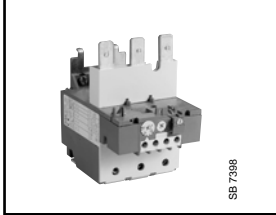
# Thermal overload relays TA... Electronic overload relays E... Overview

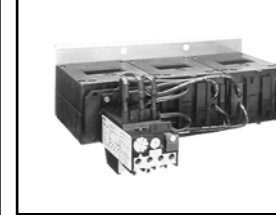
				
<b>TA80DU</b>	<b>TA110DU</b>	<b>TA200DU</b>	<b>TA450DU/SU</b>	<b>T900DU/SU</b>
29 A 60 ... 80 A	65 A 80 ... 110 A	80 ... 200 A	<b>DU</b> 130 ... 185 285 ... 400	<b>SU</b> A 40 ... 60 A A 285 ... 400 A
A95, A110 AF95, AF110 AE95, AE110 TAE95, TAE110		A145, A185 AF145, AF185	A210 ... A300 AF210 ... AF300	
no mounting kit required, direct mounting			DT450/A	AT900/EH
–	–	–	–	DS25-A
–	–	–	–	DR25-A
DB80	DB200		–	–
–	–	–	–	–
TA80DU ... V1000	TA110DU ... V1000	T/TA200DU ... V1000	T/TA450DU/SU ... V1000	–

			
<b>E200DU</b>	<b>E320DU</b>	<b>E500DU</b>	<b>E800DU</b>
60 A 200 A	100 A 320 A	150 A 500 A	250 A 800 A
A145, A185, AF145, AF185	A210, A260, A300 AF210, AF260, AF300	AF400, AF460	AF580, AF750
no mounting kit required, direct mounting		DT500 / AF460	DT800 / AF750
LT200E	LT320E	LT500E	LT800E
–	–	–	–

class 10, 20, 30 adjustable  
EEx e/ATEX

# Motor protection

## Selection of the protection device

### Motor protection - General aspects

Selection of an adequate motor protection is of great importance with regard to the operational reliability and service life of a motor.

The effectiveness of the available motor protection devices depends on the range of application.

The following shows a summary which facilitates the correct choice. Since no general rules exist, we will gladly give you further advice in special cases such as heavy starting.

Protection against:

- overload
- phase failure imbalance
- phase loss

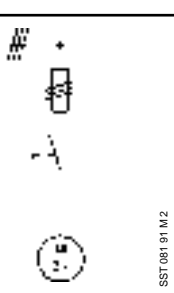
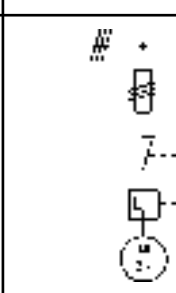
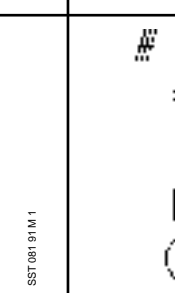
Efficiency	Protection device current-dependent: Fuses	Overload relays with protection device in case of phase failure	Protection device, temperature-dependent: Thermistor machine protection CUSTORAPID®
Reasons for unwanted overloading of the motor winding			
1 Current overloading	<input type="checkbox"/>		
2 Rated duty types S1-S8 to IEC 34-1	<input type="checkbox"/>	<input checked="" type="checkbox"/>	<input checked="" type="checkbox"/>
3 Operation when starting, braking, reversing	<input type="checkbox"/>	<input checked="" type="checkbox"/>	<input checked="" type="checkbox"/>
4 Operation at starting rates Schalthäufigkeit 15 ops./h	<input type="checkbox"/>	<input checked="" type="checkbox"/>	<input checked="" type="checkbox"/>
5 Locked motor	<input checked="" type="checkbox"/>	<input checked="" type="checkbox"/>	<input checked="" type="checkbox"/> In the case of motors with thermally critical rotor
6 Overload at phase failure	<input type="checkbox"/>	<input checked="" type="checkbox"/>	<input checked="" type="checkbox"/>
7 Over-/undervoltage in supply mains	<input type="checkbox"/>	<input checked="" type="checkbox"/>	<input checked="" type="checkbox"/>
8 Variation of frequency in supply mains	<input type="checkbox"/>	<input checked="" type="checkbox"/>	<input checked="" type="checkbox"/>
9 Increased ambient temperature	<input type="checkbox"/>	<input checked="" type="checkbox"/>	<input checked="" type="checkbox"/>
10 External heating of the motor (e.g.: bearing heating)	<input type="checkbox"/>	<input type="checkbox"/>	<input checked="" type="checkbox"/>
11 Obstruction to motor cooling	<input type="checkbox"/>	<input type="checkbox"/>	<input checked="" type="checkbox"/>

Efficiency of protection device:

- not effective
- partly effective
- fully effective

### Note on fuses

Fuses do not protect a motor against overload. They serve only as short-circuit protection of switchgear and cables.

For direct starting, fuses of around 1.5 to 2.5 times the rated current should be used. A fuse must withstand 1.3 times its rated current for a sustained period. This would entail thermal overload of the motor. In order to protect motors against short-circuits, it is advisable to use fuses aM in conjunction with the thermal overload relay. The specifications in relation to short-circuit protection for contactors and overload relays must be noted when selecting the rating of fuses or circuit-breakers.

# Motor protection with FieldBusPlug devices

## The FieldBusPlug concept

This new ABB product family is a communication device range with switching and automation components which can be combined easily with standard fieldbus systems.

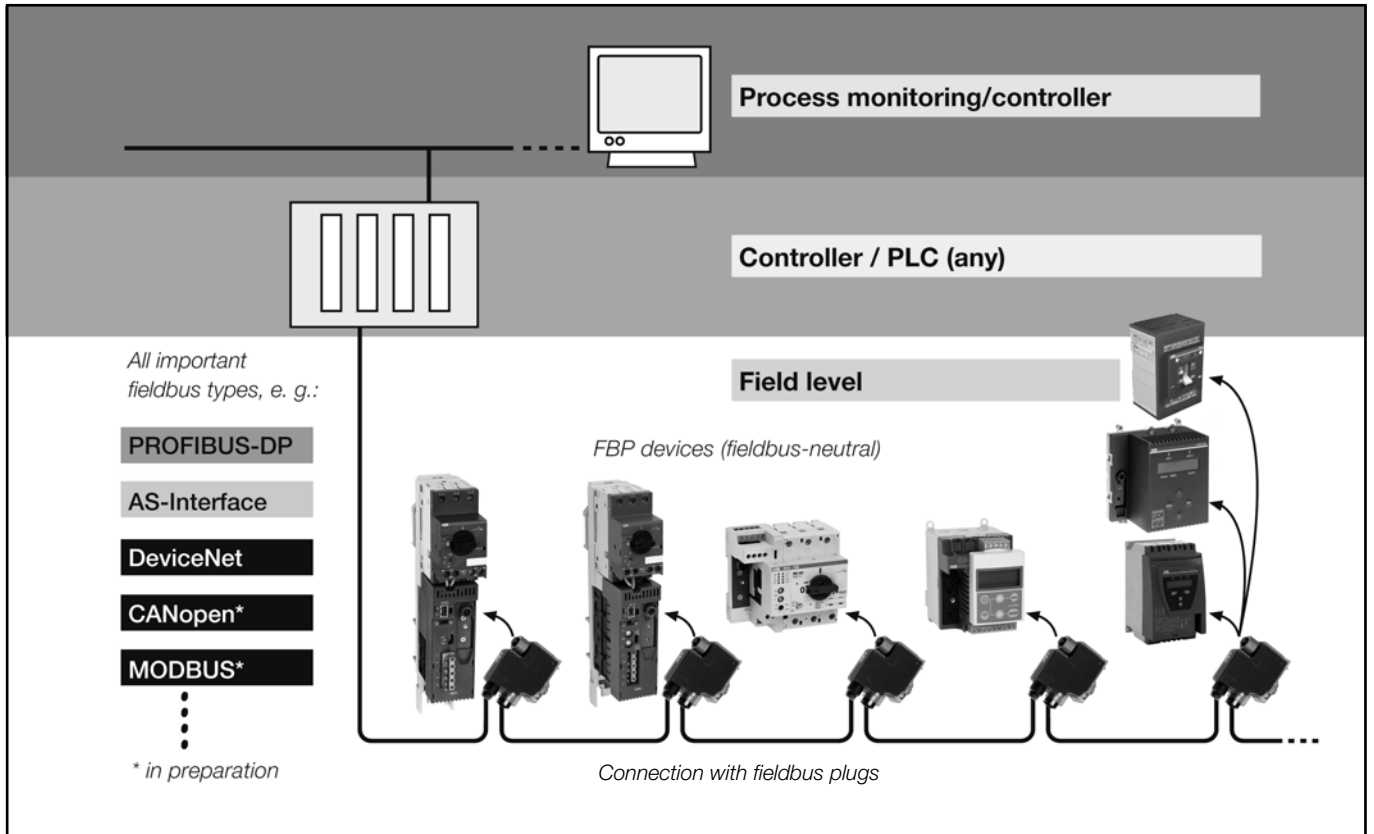

## One device for all fieldbus types

Each complete device, and each function module within the product family, has a fieldbus-neutral interface. A specially prefabricated connection cable establishes the communications connection with its bus-specific plug interface. In this way, flexibility, transparency and reliability in the process are achieved. The connecting, operating and diagnostic elements are placed at the front of all devices providing increased ease of installation.

## The components

The fieldbus plug (FieldBusPlug) is the central communications element of the new product family. It connects devices and device combinations of different functions and characteristics as well as simple sensors with automation devices.

A great variety of switching and automation modules belong to the product family separated into similar performance characteristics, e.g. devices for motor protection, motor control and standard sensors.

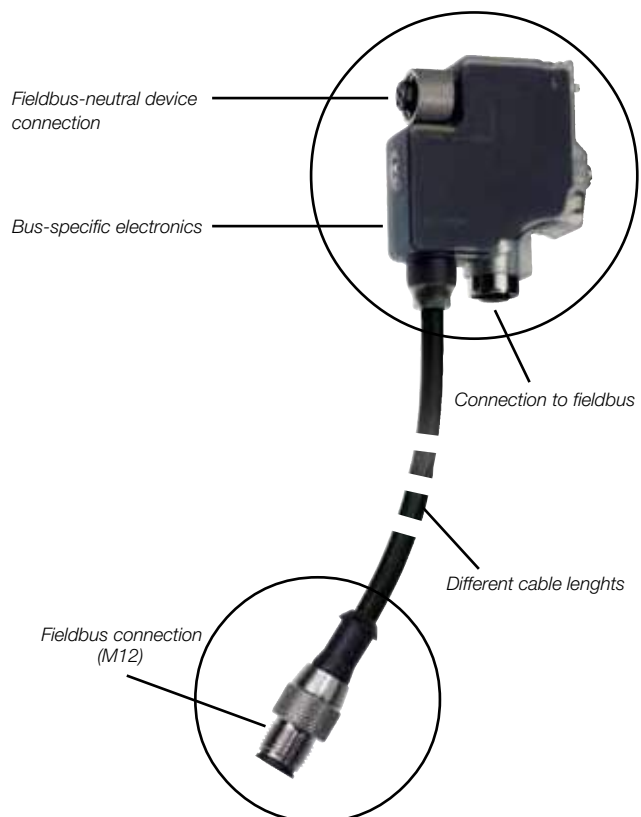

# Thermal overload relays

## T7DU, TA25DU, TA25DU... V1000, TA42DU, TA42DU... V1000

### Ordering details



T7DU

SST00238



TA25DU

SB 7386

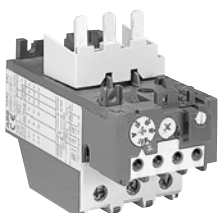

TA42DU

SB 7361

Type	Order code	Setting range		Max.fuse See page 20		Price / piece	Pack- ing unit piece	Weight per piece kg
		A	... A	aM A	gL/gG A			
<b>T7DU Thermal overload relays for mini contactors B6, BC6, B6S, BC6, VB6, VBC6, B7, BC7, B7S, BC7, VB7, VBC7,</b>								
T 7DU 0.16	1SAZ 111 301 R 0001	0.1	... 0.16		0.5		1	0.070
T 7DU 0.24	1SAZ 111 301 R 0002	0.16	... 0.24		1		1	0.070
T 7DU 0.4	1SAZ 111 301 R 0003	0.24	... 0.4		2		1	0.070
T 7DU 0.6	1SAZ 111 301 R 0004	0.4	... 0.6		2		1	0.070
T 7DU 1.0	1SAZ 111 301 R 0005	0.6	... 1.0		4		1	0.070
T 7DU 1.6	1SAZ 111 301 R 0006	1.0	... 1.6		6		1	0.070
T 7DU 2.4	1SAZ 111 301 R 0007	1.6	... 2.4		6		1	0.070
T 7DU 4.0	1SAZ 111 301 R 0008	2.4	... 4.0		10		1	0.070
T 7DU 6.0	1SAZ 111 301 R 0009	4.0	... 6.0		10		1	0.070
T 7DU 9.0	1SAZ 111 301 R 0010	6.0	... 9.0		10		1	0.070
T 7DU12.0	1SAZ 111 301 R 0011	9.0	... 12.0		20		1	0.070
<b>TA25DU for contactors A9 ... A40 and BC9 ... BC30</b>								
TA25DU 0.16	1SAZ 21 1201 R1005	0.1	... 0.16	–	0.5		1	0.150
TA25DU 0.25	1SAZ 21 1201 R1009	0.16	... 0.25	–	0.63		1	0.150
TA25DU 0.4	1SAZ 21 1201 R1013	0.25	... 0.4	–	1.25		1	0.150
TA25DU 0.63	1SAZ 21 1201 R1017	0.4	... 0.63	–	2		1	0.150
TA25DU 1.0	1SAZ 21 1201 R1021	0.63	... 1.0	2	4		1	0.150
TA25DU 1.4	1SAZ 21 1201 R1023	1.0	... 1.4	2	4		1	0.150
TA25DU 1.8	1SAZ 21 1201 R1025	1.3	... 1.8	4	6		1	0.150
TA25DU 2.4	1SAZ 21 1201 R1028	1.7	... 2.4	4	6		1	0.150
TA25DU 3.1	1SAZ 21 1201 R1031	2.2	... 3.1	6	10		1	0.150
TA25DU 4.0	1SAZ 21 1201 R1033	2.8	... 4.0	6	10		1	0.150
TA25DU 5.0	1SAZ 21 1201 R1035	3.5	... 5.0	10	16		1	0.150
TA25DU 6.5	1SAZ 21 1201 R1038	4.5	... 6.5	16	20		1	0.150
TA25DU 8.5	1SAZ 21 1201 R1040	6.0	... 8.5	20	25		1	0.150
TA25DU 11	1SAZ 21 1201 R1043	7.5	... 11	25	35		1	0.150
TA25DU 14	1SAZ 21 1201 R1045	10	... 14	25	35		1	0.150
TA25DU 19	1SAZ 21 1201 R1047	13	... 19	35	50		1	0.150
TA25DU 25	1SAZ 21 1201 R1051	18	... 25	50	63		1	0.150
TA25DU 32	1SAZ 21 1201 R1053	24	... 32 (1)	63	80		1	0.170
(1) With terminal block DX25: 1 x 16 mm <sup>2</sup>								
<b>TA25DU ... V1000 (EEx e) for contactors A9 ... A40, BC9 ... BC30</b>								
TA25DU 0.16	V1000 1SAZ 21 1301 R1005	0.1	... 0.16	–	0.50		1	0.150
TA25DU 0.25	V1000 1SAZ 21 1301 R1009	0.16	... 0.25	–	0.63		1	0.150
TA25DU 0.4	V1000 1SAZ 21 1301 R1013	0.25	... 0.4	–	1.25		1	0.150
TA25DU 0.63	V1000 1SAZ 21 1301 R1017	0.4	... 0.63	–	2		1	0.150
TA25DU 1.0	V1000 1SAZ 21 1301 R1021	0.63	... 1.0	2	4		1	0.150
TA25DU 1.4	V1000 1SAZ 21 1301 R1023	1.0	... 1.4	2	4		1	0.150
TA25DU 1.8	V1000 1SAZ 21 1301 R1025	1.3	... 1.8	4	6		1	0.150
TA25DU 2.4	V1000 1SAZ 21 1301 R1028	1.7	... 2.4	4	6		1	0.150
TA25DU 3.1	V1000 1SAZ 21 1301 R1031	2.2	... 3.1	6	10		1	0.150
TA25DU 4.0	V1000 1SAZ 21 1301 R1033	2.8	... 4.0	6	10		1	0.150
TA25DU 5.0	V1000 1SAZ 21 1301 R1035	3.5	... 5.0	10	16		1	0.150
TA25DU 6.5	V1000 1SAZ 21 1301 R1038	4.5	... 6.5	16	20		1	0.150
TA25DU 8.5	V1000 1SAZ 21 1301 R1040	6.0	... 8.5	20	25		1	0.150
TA25DU 11	V1000 1SAZ 21 1301 R1043	7.5	... 11.0	25	35		1	0.150
TA25DU 14	V1000 1SAZ 21 1301 R1045	10	... 14	25	35		1	0.150
TA25DU 19	V1000 1SAZ 21 1301 R1047	13	... 19	35	50		1	0.150
TA25DU 25	V1000 1SAZ 21 1301 R1051	18	... 25	50	63		1	0.150
TA25DU 32	V1000 1SAZ 21 1301 R1053	24	... 32 (1)	63	80		1	0.170
(1) With terminal block DX25: 1 x 16 mm <sup>2</sup>								
<b>TA 42DU for contactors A30, A40 and BC30</b>								
TA 42DU 25	1SAZ 31 1201 R1001	18	... 25	50	63		1	0.330
TA 42DU 32	1SAZ 31 1201 R1002	22	... 32	63	80		1	0.330
TA 42DU 42	1SAZ 31 1201 R1003	29	... 42	80	100		1	0.330
<b>TA42DU ... V1000 (EEx e) for contactors A30, A40 and BC30</b>								
TA42DU 25	V1000 1SAZ 31 1301 R1001	18	... 25	50	63		1	0.330
TA42DU 32	V1000 1SAZ 31 1301 R1002	22	... 32	63	80		1	0.330
TA42DU 42	V1000 1SAZ 31 1301 R1003	29	... 42	80	100		1	0.330

# Thermal overload relays

## TA75DU, TA80DU, TA110DU, TA200DU

### Ordering details

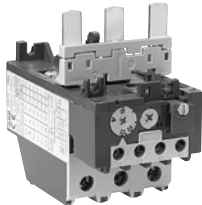

TA75DU

SB 7387

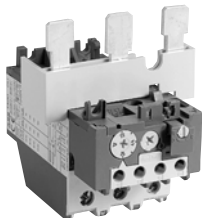

TA80DU

SB 7389

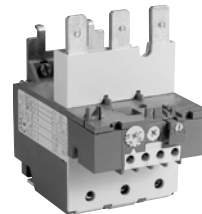

TA110DU

SB 7386

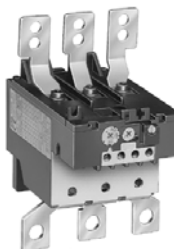

TA200DU

SST02 99

Type	Order code	Setting range	Max.fuse See page 21 aM gL/gG A A	Price / piece	Pack- ing unit piece	Weight / piece kg
	A ... A					

#### TA75DU for contactors A50 ... A75 and AE50 ... AE75

TA75DU 25	1SAZ 32 1201 R1001	18 ... 25	50	63	1	0.330
TA75DU 32	1SAZ 32 1201 R1002	22 ... 32	63	80	1	0.330
TA75DU 42	1SAZ 32 1201 R1003	29 ... 42	80	100	1	0.330
TA75DU 52	1SAZ 32 1201 R1004	36 ... 52	100	125	1	0.330
TA75DU 63	1SAZ 32 1201 R1005	45 ... 63	125	160	1	0.330
TA75DU 80	1SAZ 32 1201 R1006	60 ... 80	160	200	1	0.330

#### TA75DU ... V1000 (EE e) for contactors A50 ... A75 and AE50 ... AE75

TA75DU 25	V1000 1SAZ 32 1301 R1001	18 ... 25	50	63	1	0.330
TA75DU 32	V1000 1SAZ 32 1301 R1002	22 ... 32	63	80	1	0.330
TA75DU 42	V1000 1SAZ 32 1301 R1003	29 ... 42	80	100	1	0.330
TA75DU 52	V1000 1SAZ 32 1301 R1004	36 ... 52	100	125	1	0.330
TA75DU 63	V1000 1SAZ 32 1301 R1005	45 ... 63	125	160	1	0.330
TA75DU 80	V1000 1SAZ 32 1301 R1006	60 ... 80	160	200	1	0.330

#### TA80DU for contactors A95, A110, AE95 and AE110

TA80DU 42	1SAZ 33 1201 R1003	29 ... 42	80	100	1	0.360
TA80DU 52	1SAZ 33 1201 R1004	36 ... 52	100	125	1	0.360
TA80DU 63	1SAZ 33 1201 R1005	45 ... 63	125	160	1	0.360
TA80DU 80	1SAZ 33 1201 R1006	60 ... 80	160	200	1	0.360

#### TA80DU ... V1000 (EE e) for contactors A95, A110, AE95 and AE110

TA80DU 42	V1000 1SAZ 33 1301 R1003	29 ... 42	80	100	1	0.360
TA80DU 52	V1000 1SAZ 33 1301 R1004	36 ... 52	100	125	1	0.360
TA80DU 63	V1000 1SAZ 33 1301 R1005	45 ... 63	125	160	1	0.360
TA80DU 80	V1000 1SAZ 33 1301 R1006	60 ... 80	160	200	1	0.360

#### TA110DU for contactors A95, A110, AE95 and AE110

TA110DU 90	1SAZ 41 1201 R1001	65 ... 90	160	200	1	0.750
TA110DU 110	1SAZ 41 1201 R1002	80 ... 110	200	224	1	0.750

#### TA110DU ... V1000 (EE e) for contactors A95, A110, AE95 and AE110

TA110DU 90	V1000 1SAZ 41 1301 R1001	65 ... 90	160	200	1	0.750
TA110DU 110	V1000 1SAZ 41 1301 R1002	80 ... 110	200	224	1	0.750

Type	Order code	Setting range	For contactor	Price / piece	Pack- ing unit piece	Weight / piece kg
		A. .. A				

#### Normal starting time class 10 A

TA200DU 90	1SAZ 421 201 R1001	66 ... 90	A145, 185			0.750
TA200DU 110	1SAZ 421 201 R1002	80 ... 110	A145, 185			0.750
TA200DU 135	1SAZ 421 201 R1003	100 ... 135	A145, 185			0.750
TA200DU 150	1SAZ 421 201 R1004	110 ... 150	A145, 185			0.750
TA200DU 175	1SAZ 421 201 R1005	130 ... 175	A145, 185			0.750
TA200DU 200	1SAZ 421 201 R1006	150 ... 200	A145, 185			0.750

#### Normal starting time class 10 A, V1000 (EE e)

TA200DU 110	V1000 1SAZ 421 301 R1002	80 ... 110	A145, 185			0.750
TA200DU 130	V1000 1SAZ 421 301 R1003	100 ... 135	A145, 185			0.750
TA200DU 150	V1000 1SAZ 421 301 R1004	110 ... 150	A145, 185			0.750
TA200DU 175	V1000 1SAZ 421 301 R1005	130 ... 175	A145, 185			0.750
TA200DU 200	V1000 1SAZ 421 301 R1006	150 ... 200	A145, 185			0.750

#### Terminal shroud for TA200

LT200/A	1SAZ 401 901 R1001					0.070
---------	--------------------	--	--	--	--	-------



# Thermal overload relays

## TA450DU/SU, T900DU/SU

### Ordering details

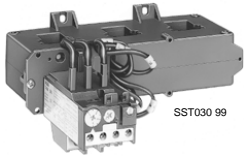

TA450DU

Type	Order code	Setting range	For contactor	Price / piece	Packing unit piece	Weight / piece kg
------	------------	---------------	---------------	---------------	--------------------	-------------------

#### Normal starting time class 10 A

TA450DU 185	1SAZ 511 201 R1001	130 ... 185	A 210, 260, 300			1.500
TA450DU 235	1SAZ 511 201 R1002	165 ... 235	A 210, 260, 300			1.500
TA450DU 310	1SAZ 511 201 R1003	220 ... 310	A 210, 260, 300			1.500

#### Normal starting time class 10 A, V1000 (EExe)

TA450DU 185 V1000	1SAZ 511 301 R1001	130 ... 185	A 210, 260, 300			1.500
TA450DU 235 V1000	1SAZ 511 301 R1002	165 ... 235	A 210, 260, 300			1.500
TA450DU 310 V1000	1SAZ 511 301 R1003	220 ... 310	A 210, 260, 300			1.500

#### Long starting time class 30

TA450SU 60	1SAZ 611 201 R1005	40 ... 60	A 145 ... 300			1.500
TA450SU 80	1SAZ 611 201 R1006	55 ... 80	A 145 ... 300			1.500
TA450SU 105	1SAZ 611 201 R1007	70 ... 105	A 145 ... 300			1.500
TA450SU 140	1SAZ 611 201 R1008	95 ... 140	A 145 ... 300			1.500
TA450SU 185	1SAZ 611 201 R1001	130 ... 185	A 145 ... 300			1.500
TA450SU 235	1SAZ 611 201 R1002	165 ... 235	A 145 ... 300			1.500
TA450SU 310	1SAZ 611 201 R1003	220 ... 310	A 145 ... 300			1.500

#### Long starting time class 30, V1000 (EExe)

TA450SU 60 V1000	1SAZ 611 301 R1005	40 ... 60	A 145 ... 300			1.500
TA450SU 80 V1000	1SAZ 611 301 R1006	55 ... 80	A 145 ... 300			1.500
TA450SU 105 V1000	1SAZ 611 301 R1007	70 ... 105	A 145 ... 300			1.500
TA450SU 140 V1000	1SAZ 611 301 R1008	95 ... 140	A 145 ... 300			1.500
TA450SU 185 V1000	1SAZ 611 301 R1001	130 ... 185	A 145 ... 300			1.500
TA450SU 235 V1000	1SAZ 611 301 R1002	165 ... 235	A 145 ... 300			1.500
TA450SU 310 V1000	1SAZ 611 301 R1003	220 ... 310	A 145 ... 300			1.500

#### Mounting kits for TA450 overload relays

DT450 /A185	1SAZ 501 901 R1001		A 145, 185			0.470
DT450 /A300	1SAZ 501 902 R1001		A 260, 300			0.470

Type	Order code	Setting range	Max.fuse See page 21 aM gL/gG A A	Price / piece	Packing unit piece	Weight / piece kg
------	------------	---------------	--	---------------	--------------------	-------------------

#### T900DU

T900DU 375	GJZ 602 1001 R 0001	265 ... 375	500		1	3.000
T900DU 500	GJZ 602 1001 R 0002	355 ... 500	800		1	3.000
T900DU 650	GJZ 602 1001 R 0003	465 ... 650	1000		1	3.000
T900DU 850	GJZ 602 1001 R 0004	610 ... 850	1250		1	3.000

#### T900SU

T900SU 375	GJZ 612 1001 R 0001	265 ... 375	500		1	1.500
T900SU 500	GJZ 612 1001 R 0002	355 ... 500	800		1	1.500
T900SU 650	GJZ 612 1001 R 0003	465 ... 650	1000		1	1.500
T900SU 850	GJZ 612 1001 R 0004	610 ... 850	1250		1	1.500

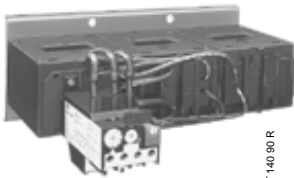

T900DU/SU

# Thermal overload relays T...

## Technical data

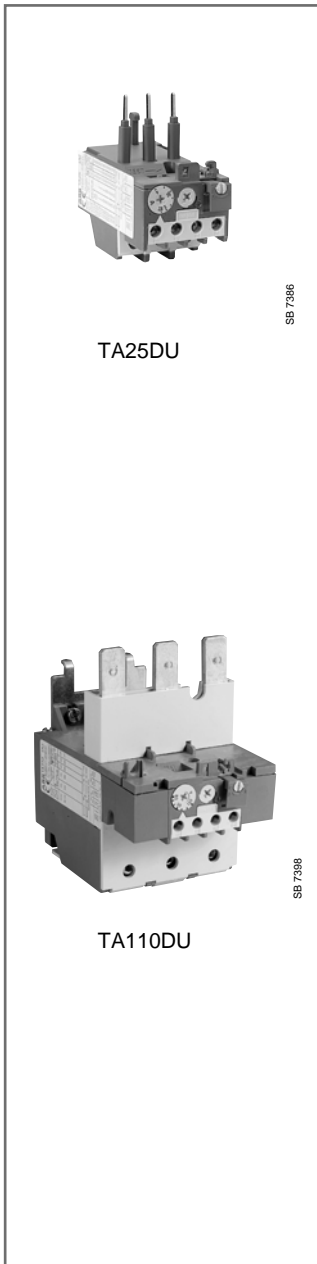

### Load rating of auxiliary contacts

Type	T7DU		TA25DU ...T900aDU/SU	
	NC 95 - 96	NO 97-98	NC 95 - 96	NO 97 - 98
Auxiliary switch				
Rated operating voltage $U_e$	500			
Rated thermal current $I_{th}$	6	6	10	6
Rated operating current $I_e$				
at AC 15 to 240 V	1.5	1.5	3	1.5
at AC 15 to 440 V	0.7	0.5	1.9	0.95
at AC 15 to 500 V	0.5	0.3	1	0.75
at DC 13 to 24 V	-	-	1.25	0.42
to 60 V	-	-	0.50	0.17
to 120 V	-	-	0.25	0.08
to 250 V	0.2	0.02	0.12	0.04
Maximum potential difference between the NO and NC contacts	500 440		500 440	
Short-circuit protection	gL/gG A 4		10	6
STOTZ circuit-breaker type:				
S 271	A	K1	K3	K1
S 281	A	K1	K3	K1

### Function of the thermal overload relays TA25DU ... T900DU/SU

Press blue button	Contacts	Relay tripped		Relay not tripped	
		Manual	Automatic	Manual	Automatic
	NC 95-96 NO 97-98	open closed	open closed	closed open	closed open
Button R	NC 95-96 NO 97-98	Reset closes when Button's pressed opens when Button's pressed	- - -	- - -	- - -
Button R/O	NC 95-96 NO 97-98	Reset closes when Button's released opens when Button's pressed	- - -	opens when Button's pressed closes when Button's released -	opens when Button's pressed closes when Button's released -

### Position of the connection terminals

TA25DU, TA42DU,  
TA75DU, TA80DU

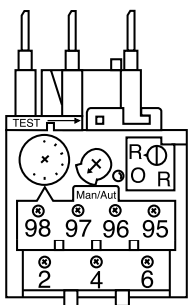

A.471

TA200DU

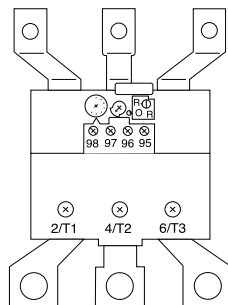

A.467

TA450DU/SU, T900DU/SU

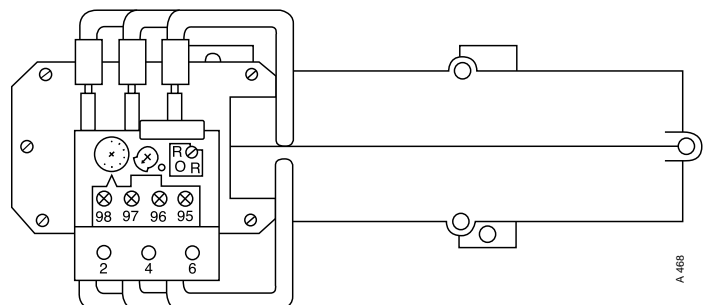

A.468

# Thermal overload relays

## Accessories

### Ordering details

Mounting kits for mounting thermal overload relays onto contactors

Relays TA25DU to TA200DU can be mounted onto the contactors without mounting kits .

#### Mounting kits for single set-ups

Type	Order code	for thermal overload relay	Mounting	Price / piece	Packing unit piece	Weight / piece kg
DB25/25 A DB25/32 A	1SAZ 201 108 R 0001 1SAZ 201 108 R 0002	TA25DU 25 A TA25DU 32 A	snapping onto		1	0.050
					1	0.075
DB80	1SAZ 301 110 R 0001	TA42DU TA75DU TA80DU	35 mm		1	0.170
DB200	1SAZ 401 110 R 0001	TA110DU TA200DU T200DU	Screw mounting		1	0.230

#### FASTON terminal blocks LC ...

##### Description

The FASTON terminal blocks are supplied as complete mounting kits for thermal overload relays TA25DU and as mounting kit for single set-ups DB25... A maximum of 2 6.3 mm tab connectors or 2 2.8 mm tab connectors can be connected per pole to the FASTON terminal blocks.

**⚠** The connection points are safe from finger-touch and safe from touch by the back of the hand to VDE 0106, Part 100.

Type	Order code	Mounting onto :	Price / piece	Packing unit piece	Weight / piece kg
LC30-T	GJL 280 1912 R 0001	Relay TA25DU		1	0.021
LC26-B1	GJL 280 1912 R 0004	Mounting kit DB25/25 A + DB25/32 A		1	0.015

#### Terminal block 10 mm<sup>2</sup>

DX25	1SAZ 20 1307 R 0002	TA25DU ≤ 25 A and DB25/25 A		1	0.030
------	---------------------	--------------------------------	--	---	-------

Type	Order code	for contactor	overload relays	Price / piece	Pack. unit piece	Weight / piece kg
------	------------	---------------	-----------------	---------------	------------------	-------------------

#### Mounting kits for mounting thermal overload relays onto contactors

DT450/A185	1 SAZ 50 1901 R1001	A145, A185	TA450		1	0.500
DT450/A300	1 SAZ 50 1902 R1001	A260, A300	TA450		1	0.750
AT900/ EH370/ EH550	GJZ 520 1911 R 0002	EH370, EH550			1set	0.800
AT900/ EH700	GJZ 520 1912 R 0002	EH700			1set	1.900
AT900/ EH800	GJZ 520 1913 R 0002	EH800			1set	3.000

#### Identification markers for thermal overload relays TA25DU ... T900DU

BA50	FPTN 472 625 R 0001	50 label carriers 50 transparent protection covers 60 non-adhesive labels 75 self-adhesive labels			Bag	0.100
------	---------------------	--	--	--	-----	-------

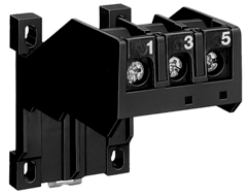

DB25

SST 182 91 R



DB80

SST 183 91 R

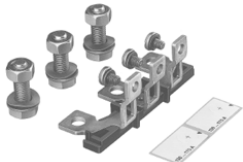

DB200

SST 279 92 R

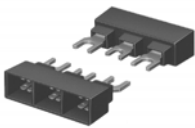

LC26-B1

ABB 860 368



DX25

SST 014 94 R

# Thermal overload relays

## Accessories

### Ordering details



Type	Order code	Mounting onto :	Price / piece	Pack. unit piece	Weight / piece kg
------	------------	-----------------	---------------	------------------	-------------------

**Terminal shroud (for protection against direct contact). Contactor terminals and TOL terminals are covered**

LT900/700	GJZ 520 1935 R 0002	T900 DU/SU + EH370/550/700			0.450
LT900/800	GJZ 520 1937 R 0002	T900DU/SU + EH800			0.600

**Terminal shroud for TA200**

LTA185-AY between A145/185 and TA200DU	1SFN 12 4704 R1000	A145, A185		1	1.000
LT200/A Load Side TA200	1SAZ 401 901 R1001	A145, A185			0.070

Type	Order code	For relay/ description	Price / piece	Pack. unit piece	Weight / piece kg
------	------------	---------------------------	---------------	------------------	-------------------

**Remote tripping control**

The coil serves to remotely trip the thermal overload relays TA25DU, T450/900DU/SU.  
The coil is not approved for continuous operation. Pulse duration 0.2 ... 0.35 s.

DS25-A-24	1SAZ 201 501 R0001	24 V	Operating-voltage $U_c$ at 50/60 Hz	1	0.100
DS25-A-48	1SAZ 201 501 R0002	48 V		1	0.100
DS25-A-110	1SAZ 201 501 R0003	110 V		1	0.100
DS25-A-220/380	1SAZ 201 501 R0005	220/380 V		1	0.100
DS25-A-500	1SAZ 201 501 R0006	500 V		1	0.100

**Remote reset coil**

The coil serves to reset the thermal overload relays TA25DU, T450/900DU/SU.  
The overload relay must be set to "manual reset" for this purpose.

The coil is not approved for continuous operation. Pulse duration 0.2 ... 0.35 s.

DR25-A-24	1SAZ 201 504 R0001	24 V	Operating-voltage $U_c$ at 50/60 Hz	1	0.100
DR25-A-48	1SAZ 201 504 R0002	48 V		1	0.100
DR25-A-110	1SAZ 201 504 R0003	110 V		1	0.100
DR25-A-220/380	1SAZ 201 504 R0005	220/380 V		1	0.100
DR25-A-500	1SAZ 201 504 R0006	500 V		1	0.100

### Circuit diagrams

TA25DU with DS25-A

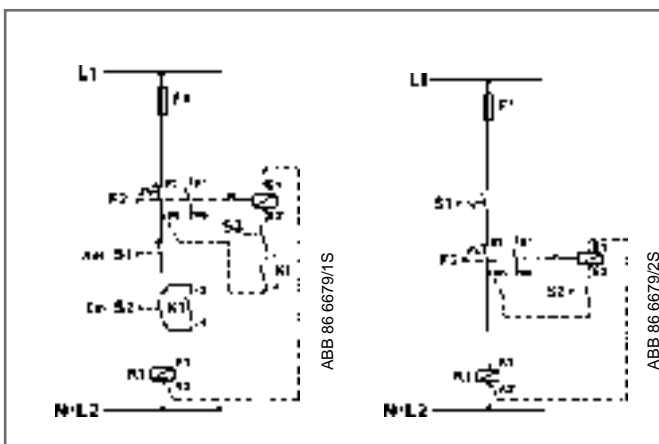

TA25DU with DR25-A

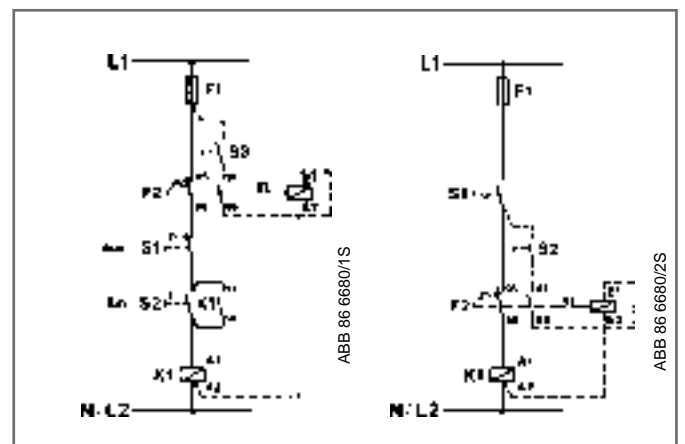

# Electronic overload relays E16DU/UMC22

## Ordering details



E 16 DU

SST 016 99



E16DU  
with A9, A12, A16

SST 016 99



UMC22-FBP

UMC22



ACS100-PAN

Display/UMC22

DB16E

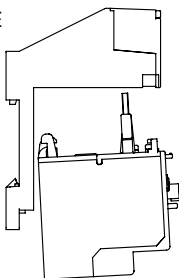

E16DU

Type	Order code	Setting range A ... A	Max. fuse		Price / piece	Pack. unit piece	Weight / piece kg
			aM A	gL/gG A			

### E16DU tripping class 10 for contactors B6, B7, BC6, BC7, B6S, B7S, A9, A12, A16

E16DU 0.32 10 ①	1SAX 111 201 R 0001	0.1 ... 0.32		1		1	0.150
E16DU 1.0 10 ①	1SAX 111 201 R 0002	0.3 ... 1.00		4		1	0.150
E16DU 2.7 10 ①	1SAX 111 201 R 0003	0.9 ... 2.70		10		1	0.150
E16DU 6.3 10 ①	1SAX 111 201 R 0004	2.0 ... 6.30		20		1	0.150
E16DU 18.9 10 ①	1SAX 111 201 R 0005	5.7 ... 18.90		50		1	0.150

### E16DU tripping class 20 for contactors B6, B7, BC6, BC7, B6S, B7S, A9, A12, A16

E16DU 0.32 20 ①	1SAX 111 301 R 0001	0.1 ... 0.32		1		1	0.150
E16DU 1.0 20 ①	1SAX 111 301 R 0002	0.3 ... 1.00		4		1	0.150
E16DU 2.7 20 ①	1SAX 111 301 R 0003	0.9 ... 2.70		10		1	0.150
E16DU 6.3 20 ①	1SAX 111 301 R 0004	2.0 ... 6.30		20		1	0.150
E16DU 18.9 20 ①	1SAX 111 301 R 0005	5.7 ... 18.90		50		1	0.150

### E16DU tripping class 30 for contactors B6, B7, BC6, BC7, B6S, B7S, A9, A12, A16

E16DU 1.0 30 ①	1SAX 111 401 R 0002	0.3 ... 1.00		4		1	0.150
E16DU 2.7 30 ①	1SAX 111 401 R 0003	0.9 ... 2.70		10		1	0.150
E16DU 6.3 30 ①	1SAX 111 401 R 0004	2.0 ... 6.30		20		1	0.150
E16DU 18.9 30 ①	1SAX 111 401 R 0005	5.7 ... 18.90		50		1	0.150

① Not suitable for single-phase motors and direct current (DC) motors!

### Universal Motor Controller UMC22-FBP, 0.2...63 A

UMC22-FBP.0	1SAJ 510 000 R 0100	0.2 ... 63				1	
-------------	---------------------	------------	--	--	--	---	--

- Integrated motor control functions – direct, reverse-start, star-delta starting, servo-drive functions
- Diagnostic functions – overload, phase failure, trip – trip categories 5, 10, 20, 30
- Integrated storage of parameters and motor data
- 6 digital inputs, 3 relay outputs

### Accessories for Universal Motor Controller UMC22-FBP

Operating, diagnostic and parameterizing device for Universal Motor Controller UMC22-FBP

- Setting of motor and bus parameters

Type	Order code			Price / piece	Pack. unit piece	Weight / piece kg
ACS100-PAN	1SAJ 510 001 R 0001				1	

### Mounting kit for separate mounting of E 16 DU on wall or Din-rail

Type	Order code	for thermal overload relays		Price / piece	Pack. unit piece	Weight / piece kg
DB16E	1SAX 101 110 R 0001	E16DU			1	0.02

# Electronic overload relays E200/320/500/800DU

## Ordering details



SIST 289 9/2 R

E200DU



E320DU

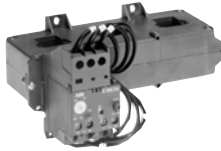

E500DU

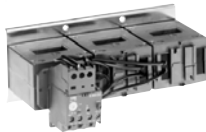

E800DU

Type	Order code	Setting range	for contactor	Price / piece	Pack. unit piece	Weight / piece kg
------	------------	---------------	---------------	---------------	------------------	-------------------

### Electronic overload relays

<b>E200DU</b>	<b>1SAX 511 001 R 0001</b>	65 ... 200	A145 ... A185		1	0.000
<b>E320DU</b>	<b>1SAX 611 001 R 0002</b>	105 ... 320	A 210 ... A300		1	
<b>E500DU</b>	<b>1SAX 711 001 R 0001</b>	170 ... 500	AF400 ... AF460		1	
<b>E800DU</b>	<b>1SAX 811 001 R 0001</b>	270 ... 800	AF580 ... AF750		1	

Type	Order code	Description
------	------------	-------------

### Mounting kits for electronic overload relays

<b>DT500/AF460 L</b>	<b>1SAX 701 902 R 1001</b>	Mounting kit for E500DU to AF400, 460 with reversing connector
<b>DT500/AF460 S</b>	<b>1SAX 701 902 R 1011</b>	Mounting kit for E500DU to AF400, 460
<b>DT800/AF750 L</b>	<b>1SAX 801 902 R 1001</b>	Mounting kit for E800DU to AF580, 750 with reversing connector
<b>DT800/AF750 S</b>	<b>1SAX 801 902 R 1011</b>	Mounting kit for E800DU to AF580, 750

### Terminal shrouds

<b>LT200E</b>	<b>1SAX 501 904 R 0001</b>	Therminal shroud for E200DU
<b>LT320E</b>	<b>1SAX 601 904 R 0001</b>	Therminal shroud for E320DU
<b>LT500E</b>	<b>1SAX 701 904 R 0001</b>	Therminal shroud for E500DU
<b>LT800E</b>	<b>1SAX 801 904 R 0001</b>	Therminal shroud for E800DU



Contactor A300 with E320DU and terminal shroud

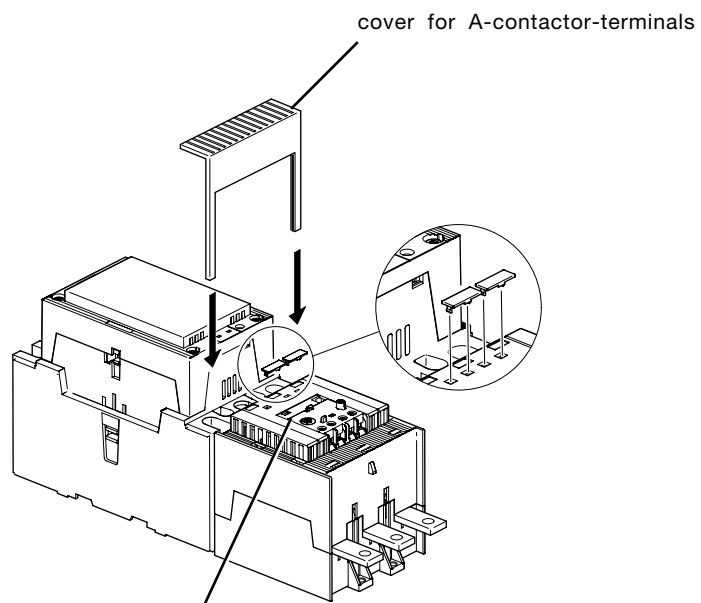

switch to adjust class 10, 20 or 30

# Thermal overload relays T...

## Description



### Application

Thermal overload relays T are used in connection with contactors A, BC, AE and EH to protect motors with a rated operating voltage of up to 690 V AC and 800 V DC.

### Product range

#### Standard relays

**Types:** T7DU, TA25DU, TA42DU, TA75DU, TA80DU, TA110DU, T/TA200DU, T/TA450DU/SU, T900DU/SU

- Relays T7 to T/TA200 are connected directly into the motor circuit and the motor current flows through them.
- Relays T/TA450DU and T900DU are powered via converters with a linear characteristic.
- Relays T/TA450SU and T900SU are powered via converters with saturation characteristic and therefore have longer tripping times.  
See section "Protection with heavy starting", see Page 16

### Special designs

Thermal overload relays with different approvals and certificates, see Page 24. Relays to protect EEx e motors, see Page 16

### Design and function

#### General

**The relays and the accessories comply with the major international (IEC), European (EN) and national standards (DIN-VDE, NFC-UTE, BS, etc...) and meet the approval and licensing regulations necessary worldwide.**

#### The thermal overload relays are three-pole relays

They have bimetallic releases (1 per phase) through which the motor current flows and are indirectly heated. The bimetallic releases bend subject to the influence of heating and this results in tripping of the relay. The auxiliary contacts change their switch position.

The relays feature a setting scale in Amperes. In compliance with international and national standards, the setting current is the rated **motor current** and not the tripping current (no tripping at  $1.05 \times I$  setting current, tripping at  $1.2 \times I$  setting current).

The **tripping curves** (starting from cold and warm state, three and two-phase) are shown in the technical data, Page 22.

The relays are constructed so that they protect themselves in the event of overload until the series-connected short-circuit protection trips, as shown in the tables.

### Technical data

All relays feature:

- **Trip-free mechanism:** Tripping in the event of a fault is not prevented even if the Reset button is pressed.
- **Temperature compensation:** - see Page 16
- **Phase failure protection in accordance with IEC 947-4-1:** This device shortens the tripping times in the event of phase failure and thus improves the motor protection within the limits of the setting range.
- **Tripping category:** 10 A, in the case of thermal overload relays T ... DU  
30, in the case of thermal overload relays T ... SU.
- **Reset and test functions,** see Page 17

### Auxiliary contacts

The relays feature two integrated auxiliary contacts

- one NC contact, marked by 95 - 96
- one NO contact, marked by 97 - 98

The two contacts are electrically isolated and are thus suitable for use in two different circuits (control circuit and signalling circuit).

# Thermal overload relays T 7DU, TA25DU ... T900DU

## Description

### Intermittent periodic duty

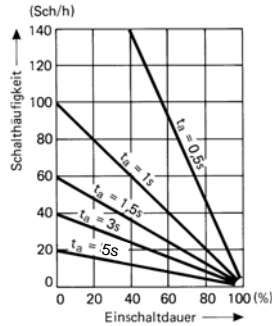

Switching frequency depending on duty ratio ED in %,  $t_a$ : Motor starting time

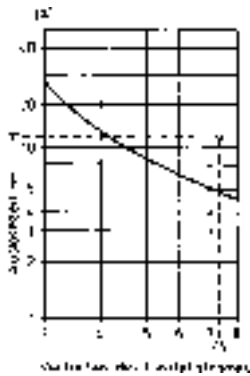

Tripping curve of overload relay T .. starting from cold state

### Switching frequency

Thermal overload relays T cannot be operated at any arbitrary switching frequency in order to avoid tripping. Applications involving up to 15 operations per hour are acceptable. Higher switching frequencies are permitted if the duty ratio and the motor starting time are allowed for and if the motor's making current does not appreciably exceed 6 times the rated operating current. Please refer to the adjacent diagram for guideline values for the permitted switching frequency.

**Example:** Starting time of the motor: 1 second

Duty ratio: 40 %

means a permitted switching frequency of max. 60 operations per hour

Use of the CUSTORAPID® motor protection is recommended for higher switching frequencies and alternating loading, e.g. for frequent starting and braking. Use of a combination of thermal overload relays and CUSTORAPID® is recommended in the case of locked rotors on motors with thermally critical rotors.

### Protection with heavy starting

Relays **T450SU/T900SU** can be used for particularly severe starting conditions. The setting ranges specified on Pages 41 and 42 apply to non-recurrent looping through of the cables. The relay may also be used for lower motor rated currents. This is achieved by looping the cables through several times. The setting range specified on the rating plate is inversely proportional to the number of cables looped through.

For instance: T450TU/SU with a setting range of 130 ... 185 A is also suitable for currents of 65 ... 92.5 A if the cables are looped through twice; the figures are 43.3 ... 61.6 A for looping the cables through three times.

### Special version for EEx e motors

Relays T7DM, TA25DU ... T900DU / SU are suitable for protection of EEx e motors. They have been tested and approved by the "German National Standards Laboratory" (PTB) in Braunschweig, Germany.

When selecting the overload relay, check suitability on the basis of the tripping curves. The values for the ratio of pick-up current  $I_a$  to rated current  $I_N$  and the shortest  $t_E$  time are crucial, and these must be specified on the PTB Approval Certificate and on the motor's rating plate. The relay must trip within the  $t_E$  time, i.e. the tripping curve, starting from cold state, must run below the coordinate point  $I_a/I_N$  and the  $t_E$  time.

### Example for suitability of an overload relay T/TA:

The motor with increased safety has the following data:

Output = 7.5 kW,  $I_a/I_N = 7.4$   $t_E$  time = 11 seconds.

In accordance with the adjacent tripping curve, the tripping time lies below the  $t_E$  time of the motor.

The special relay version for EEx e motors differs from the normal version as follows:

### Special test of the tripping times at the works

### Special order code

Tripping curves for the individual setting ranges and the PTB Approvals Certificates may be ordered.

### Reference numbers of the PTB:

Type	Reference No. of the PTB	Type	Reference No. of the PTB
T7DU V1000	3.43-187/98	T / TA200DU V1000	3.53-5315/93
TA25DU V1000	3.53/38 7.3023	T / TA450DU, T900DU V1000	3.53/38 1.671
TA42DU, TA75DU, TA80DU V1000	3.53/38 0.418	T450SU, T900SU V1000	3.53/38 1.672
TA110DU V1000	3.43-760/98		

## Limit values for tripping at ambient temperatures other than 20 °C

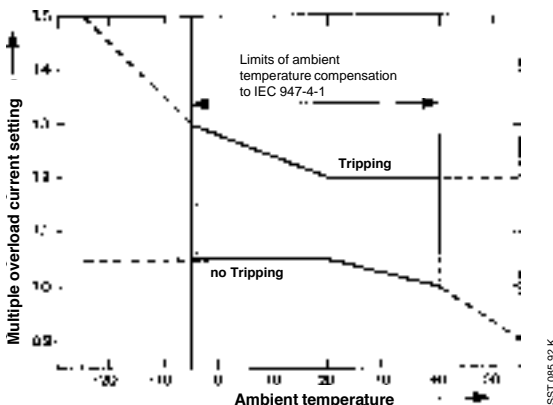

### Ambient temperature compensation :

The overload relays are protected against influences of ambient temperature by a bimetallic compensation element which detects the ambient temperature.

This design means that tripping occurs between -5 °C and +40 °C within the ranges defined by IEC 947-4-1. See the adjacent curve for the extended range of -25 °C resp. +55 °C.

### Example :

Tripping at -25 °C. Tripping occurs at  $\leq 1.5$  times the setting current.

### Reset :

Types E16DU, T7DU, TA25DU ... T90DU/SU feature a convertible Manual/Automatic reset.

### Condition as delivered :



Manual reset.



# Thermal overload relays T

## Technical data

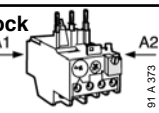
### General technical data

Type	T7DU	TA25DU	TA42DU	TA75DU
<b>Standards:</b> (major international European and national standards)	IEC 947-4-1, VDE 0660, NFC 63 650, BS 4941, EN 60947-4-1			
<b>Approvals, certificates</b>	see page 24			
<b>Rated insulation voltage <math>U_i</math></b> to IEC 158-1, IEC 947-4-1	V	690	660/690	
<b>Impulse withstand voltage <math>U_{imp}</math></b> to IEC 947-4-1	kV	6	6	
<b>Permissible ambient temperature</b> – Storage temperature – for operation (compensated)	°C °C	– 40 to +70 – 25 to +55 (limit values, see page 18)		
<b>Climatic resistance</b> to DIN 50017	Resistant to changeable climate KFW, 30 cycles			
<b>Mounting position</b>	any, but please avoid vertical mounting position wherever possible			
<b>Resistance to shock</b> at rated current $I_e$ • critical shock direction A1, A2	shock duration ms 		15	
	multiple of g	10	12	
<b>Resistance to vibration:</b> (±1 mm, 50 Hz)	multiple of g	4	8	
<b>Mounting</b> – onto contactor – with AB.. mounting kit	hooking beneath the contactor, screwing on its main terminals by screws: 2 x M4 or  35 mm EN 50022			
<b>Connection terminals and attachment type</b> <b>Main conductors</b> (motor side)	TA25DU setting ranges: 0.1...0.16 A 24...32 A to 18...25 A			
• Screw terminals – Screw terminal – with terminal block – with busbars or cable lugs	M3.5 – –	M4 – –	– M5 –	M6 – –
• Connection cross-sections – single-core or stranded – flexible with wire end ferrule – busbars	mm <sup>2</sup> mm <sup>2</sup> mm	2 x 0.75 ... 2.5 2 x 0.5 ... 1.5 –	– – –	1 x 2.5 ... 25 or 2 x 2.5 ... 16 1 x 2.5 ... 25 or 2 x 2.5 ... 10 –
<b>Connections and auxiliary connectors</b> • Screw terminal (screw size) – with self-disengaging clamping piece	M 3.5			
• Connection cross-section – single-core or stranded – flexible with wire end ferrule	mm <sup>2</sup> mm <sup>2</sup>	2 x 0.75 ... 2.5 2 x 0.5 ... 1.5	2 x 0.75 ... 4 2 x 0.75 ... 2.5	
<b>Enclosure</b> to IEC 144, IEC 529	All terminals are safe from finger-touch and safe from touch by the back of the hand to VDE 0106, Part 100 (no extra terminal shrouds are required up to and including TA 110 DU)			

### Technical data of the conducting paths

Type	T7DU	TA25DU	TA42DU	TA75DU	TA80DU	TA110DU	T/TA200DU	T/TA450DU	T900DU	T/TA450SU/T900SU
<b>Number of paths</b>	3									
<b>Setting ranges</b>	see Ordering details									
<b>Tripping class</b> to IEC 947-4-1 / VDE 0660, Part 1021	10								30	
<b>Frequency range</b> Hz	0 ... 400							50/60		
<b>Switching frequency</b> without early tripping	up to 15 ops./h or 60 ops./h with 40 % if the breaking current does not exceed 6 x $I_n$ and the starting time does not exceed 1 s									
<b>Resistance</b> per phase in mΩ and heat dissipation per phase in W at maximum setting current	see page 20 and 21									
<b>Required fuses</b> for short-circuit protection	see page 20 and 21									

# Thermal overload relays T

## Technical data

### General technical data (cont.)

	TA80DU	TA110DU	T/TA200DU	T/TA450DU/SU	T900DU/SU
	IEC 947-4-1, VDE 0660, NFC 63 650, BS 4941, EN 60947-4-1				
	see page 24				
V	660/690			1000	
kV	6			8	
°C	- 40 to +70				
°C	- 25 to +55 (limit values, see page 18)				
	Resistant to changeable climate KFW; 30 cycles				
	any, but please avoid vertical mounting position wherever possible				
ms	15				
x g	12				
x g	8				
	M6 –	4 screws M5			4 screws M6
	M6 – –	HC, M8 – –	– – M10	– – M10	– – M10
mm <sup>2</sup>	1 x 2.5 ... 25 or 2 x 2.5 ... 16	16 ... 35	25 ... 120	2 x 240	2 x 300
mm <sup>2</sup>	1 x 2.5 ... 25 or 2 x 2.5 ... 10	16 ... 35	25 ... 95	2 x 240	2 x 300
mm	–	–	20 x 4	25 x 5	40 x 5. 6 and 8
	M 3.5				
mm <sup>2</sup>	2 x 0.75 ... 4				
mm <sup>2</sup>	2 x 0.75 ... 2.5				
	All terminals are safe from finger-touch and safe from touch by the back of the hand to VDE 0106, part 100.		All terminals are safe from finger-touch and safe from touch by the back of the hand to VDE 0106, part 100, only with additional terminal shrouds.		

# Thermal overload relays T

## Technical data

### Resistances and power losses per phase Short-circuit protection

Setting ranges	Short-circuit protection (fuses, circuit-breakers)			Assignment class 1 (1)		Resistance per phase mW	Power loss per phase at upper current setting W
	Assignment class 2 (1)			Assignment class 1 (1)			
from ... to A ... A	gL/gG A	aM A	S 223 K A	gL/gG A	S 223 K		

### Thermal overload relay T7DU

0.1 ... 0.16	0.5			20	K 6	62.300	1.6
0.16 ... 0.24	1			20		27.000	1.6
0.24 ... 0.40	2			20		11.700	1.9
0.4 ... 0.60	2			20		4.610	1.7
0.6 ... 1.00	4			20		1.660	1.7
1.0 ... 1.60	6			20		0.630	1.6
1.6 ... 2.40	6			20	K 10	0.270	1.6
2.4 ... 4.00	10			20		0.107	1.7
4.0 ... 6.00	10			20		0.049	1.8
6.0 ... 9.00	10			20	K 25	0.021	1.7
9.0 ... 12.00	20			20		0.010	1.4

Setting ranges	Short-circuit protection (fuses, circuit-breakers)			Assignment class 1 (1)		Resistance per phase mW	Power loss per phase at upper current setting W
	Assignment class 2 (1)			Assignment class 1 (1)			
from ... to A ... A	gL/gG A	aM A	S 223 K A	gL/gG A	S 223 K		

### Thermal overload relay TA25DU

0.1 ... 0.16	0.5	—	—	25	K6	85850.000	2.2
0.16 ... 0.25	0.63	—	—	25		35150.000	2.2
0.25 ... 0.4	1.25	—	0.5	25		13750.000	2.2
0.4 ... 0.63	2	—	1.0	25		5370.000	2.2
0.63 ... 1.00	4	2	1.0	25		2190.000	2.2
1.0 ... 1.40	4	2	1.6	25		1120.000	2.2
1.3 ... 1.80	6	4	2	25		670.000	2.2
1.7 ... 2.40	6	4	3	25	K10	383.000	2.2
2.2 ... 3.10	10	6	3	25		229.000	2.2
2.8 ... 4.00	10	6	4	25		137.000	2.2
3.5 ... 5.00	16	10	6	25		87.500	2.2
4.5 ... 6.50	20	16	8	25	K25	51.000	2.2
6.0 ... 8.50	25	20	10	25		30.400	2.2
7.5 ... 11.00	35	25	16	—		18.200	2.2
10 ... 14.00	35	25	16	—		11.200	2.2
13 ... 19.00	50	35	20	—	K40	6.300	2.3
18 ... 25.00	63	50	25	—		4.700	2.9
24 ... 32.00	80	63	32	—		3.2.000	3.3

(1) Assignment class 1 to IEC 947-4-13: A short-circuit may cause damage to the relay necessitating exchange. (Corresponds to class a to IEC 292-1)  
Assignment class 2 to IEC 947-4-12: No damage or changes to the response values occur in the event of a short-circuit (corresponds to class c to IEC 292-1).

# Thermal overload relays T

## Technical data

### Resistances and power losses per phase Short-circuit protection

Setting range from ... to A <b>A</b>	Short-circuit protection (fuses, circuit-breakers) Assignment class 2 (1)				Assignment class 1(1)		Resistance per phase mW	Power loss per phase at upper current setting W
	gL / gG A	aM A	S 273 A	S 703 A	gL / gG A			

#### Thermal overload relay TA42DU

18 ... <b>25</b>	63	50	50	50	160		5.5	3.43
22 ... <b>32</b>	80	63	50	50	160		2.89	2.91
29 ... <b>42</b>	100	80	63	63	160		1.84	3.24

#### Thermal overload relay TA75DU

18 ... <b>25</b>	63	50	50	50	160		5.5	3.43
22 ... <b>32</b>	80	63	50	50	160		2.89	2.91
29 ... <b>42</b>	100	80	63	63	160		1.84	3.24
36 ... <b>52</b>	125	100	63	80	160		1.3	3.51
45 ... <b>63</b>	160	125	–	100	250		0.936	3.72
60 ... <b>80</b>	200	160	–	100	250		0.615	3.94

#### Thermal overload relay TA80DU

29 ... <b>42</b>	100	80	63	63	160		1.84	3.24
36 ... <b>52</b>	125	100	63	80	160		1.3	3.51
45 ... <b>63</b>	160	125	–	100	250		0.936	3.72
60 ... <b>80</b>	200	160	–	100	250		0.615	3.94

Setting range from ... to A <b>A</b>	Short-circuit protection (fuses, circuit-breakers) Assignment class 2 (1)		Assignment class 1 (1)		Resistance per phase mW	Power loss per phase at upper current setting W
	gL/gG A	aM A	gL/gG A			

#### Thermal overload relay TA110DU

65 ... <b>90</b>	200	160	250	0.540	4.37
80 ... <b>110</b>	224	200	315	0.378	4.57

#### Thermal overload relay TA200DU

100 ... <b>135</b>	224	200	315	0.318	5.79
110 ... <b>150</b>	250	224	355	0.255	5.74
130 ... <b>175</b>	315	250	400	0.214	6.55
150 ... <b>200</b>	315	250	500	0.182	7.28

#### Thermal overload relay TA450SU

40 ... <b>60</b>	125	100	not applicable	–	2.2
55 ... <b>80</b>	160	125	to	–	2.2
70 ... <b>105</b>	200	160	overload relays with	–	2.2
95 ... <b>140</b>	315	250	current transformer	–	2.2

#### Thermal overload relay TA450DU/SU

130 ... <b>185</b>	355	250	not applicable	–	2.2
165 ... <b>235</b>	400	315	to	–	2.2
220 ... <b>310</b>	500	400	overload relays with	–	2.2
285 ... <b>400</b>	630	500	current transformer	–	2.2

#### Thermal overload relay T900DU/SU

265 ... <b>375</b>	500	400	not applicable	–	2.2
355 ... <b>500</b>	800	630	to	–	2.2
465 ... <b>650</b>	1000	800	overload relays with	–	2.2
610 ... <b>850</b>	1250	1000	current transformer	–	2.2

(1) Assignment class 1 to IEC 947-4-13: A short-circuit may cause damage to the relay necessitating exchange. (Corresponds to class a to IEC 292-1)  
Assignment class 2 to IEC 947-4-12: No damage or changes to the response values occur in the event of a short-circuit (corresponds to class c to IEC 292-1).

# Thermal overload relays

## T7DU, TA25DU ... T200DU, T450DU, T900DU

### Tripping curves



SB 7386

**TA25DU**

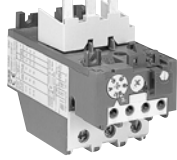

SB 7381

**TA42DU**

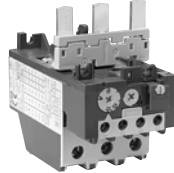

SB 7387

**TA75DU**

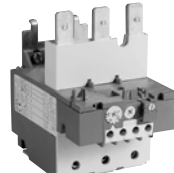

SB 7388

**TA110DU**

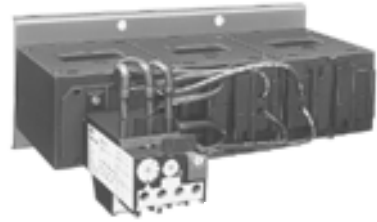

SST 140 90 R

**T900DU**

Thermal overload relays **T ... DU** are three-pole relays which can be converted from manual to automatic reset. The Reset button can also be used for disconnection. The built-in auxiliary contacts are electrically isolated and are therefore suitable for two different circuits (control circuit and signalling circuit). All relays feature a facility for temperature

compensation and phase failure protection. The overload relays up to size TA110DU are safe from finger-touch and safe from touch by the back of the hand.

Terminal shrouds are available for size T200DU to T900DU/SU. Terminal connections are delivered in open position, with Pozidrive cross-head screws (±) and screwdriver guide.

### Tripping curves of the thermal overload relays (group curves)

**T7DU**

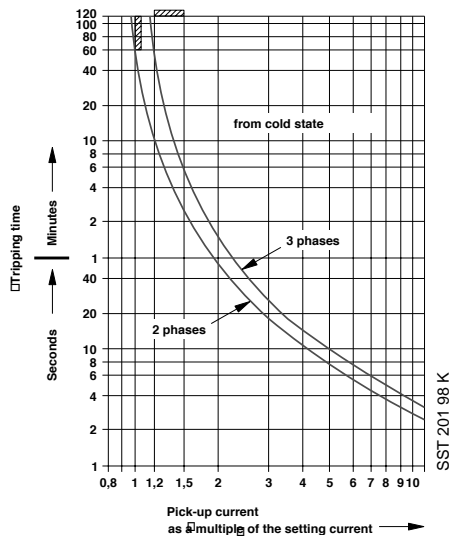

**TA25DU**

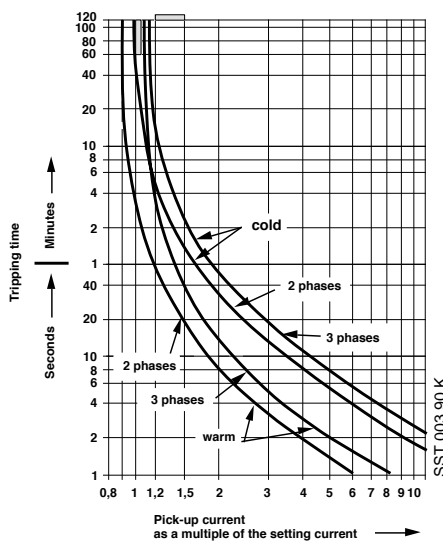

**TA42DU / TA75DU / TA80DU**

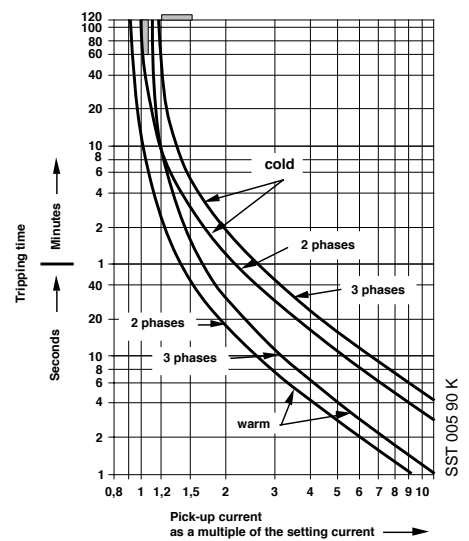

**T / TA200DU**

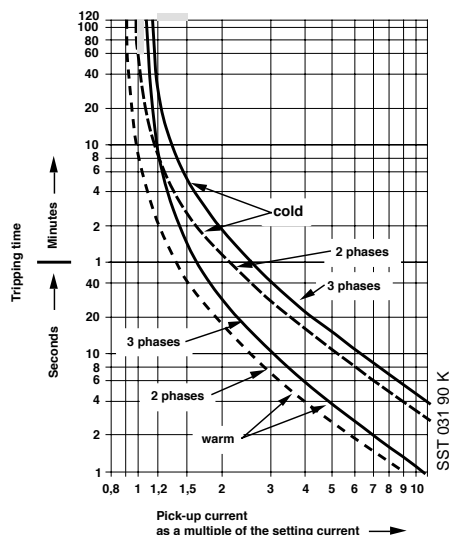

**T450DU / T900DU**

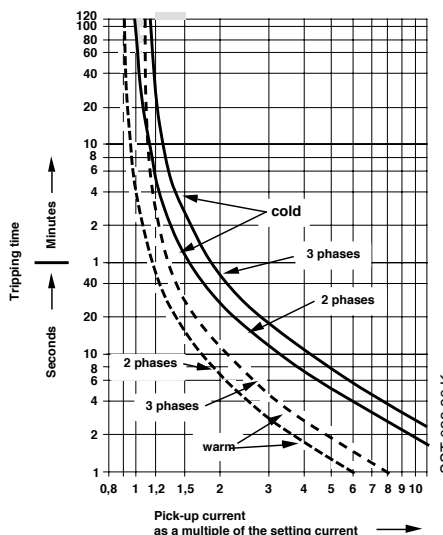

**T / TA450SU / T900SU**

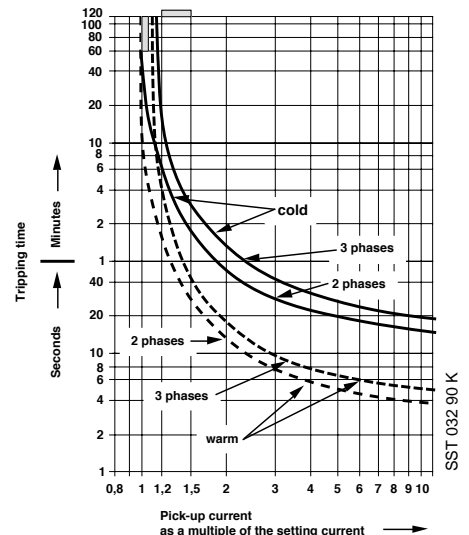

# Thermal overload relays T..., V1000

for EEx e motors

## Selection table

Selection table for suitability of the overload relays for EEx e motors.

Tripping times of the thermal overload relays as a function of a multiple of the setting current from cold state (tolerance  $\pm 20$  of the tripping time); PTB approvals, see Page 18

Setting range of the thermal overload relays from ... to A A		Tripping times of the thermal overload relays at multiple of setting current:					
		3 s	4 s	5 s	6 s	7.2 s	8 s
<b>Thermal overload relays TA25DU ... V1000</b>							
0.1 ... 0.16		17.3	10	7	5.6	4.5	4
0.16 ... 0.25		16.8	10	7.2	6	4.7	4.3
0.25 ... 0.4		16.3	10	7	5.6	4.4	3.9
0.4 ... 0.63		17.3	10.3	7.1	5.7	4.5	4
0.63 ... 1.0		20	12.6	8.4	6.7	5.3	4.5
1.0 ... 1.4		18.3	11.2	8	6.3	5	4.6
1.3 ... 1.8		18.8	11.1	7.5	6	4.7	4.2
1.7 ... 2.4		19.6	11.5	8	6	4.9	4.5
2.2 ... 3.1		18.3	10.5	7.6	6	4.7	4.2
2.8 ... 4.0		18.8	11.2	8	6.1	4.7	4.2
3.5 ... 5.0		17.8	10.9	7.7	6	4.5	4.1
4.5 ... 6.5		17.8	10.5	7.5	5.6	4.6	4
6.0 ... 8.5		17.8	10.9	7.7	6.1	5	4.5
7.5 ... 11		18.8	11.5	8.3	6.5	5.1	4.5
10 ... 14		17.8	10.9	7.7	6	4.7	4.2
13 ... 19		20.5	11.9	8.8	6	4.7	4
18 ... 25		22.4	13.3	8	6.8	5	4.5
24 ... 32		23.7	14	10	7.7	6	5.3
<b>Thermal overload relays TA42DU, TA75DU, TA80DU ... V1000</b>							
18 ... 25		41	23.2	16	11.8	9	7.5
22 ... 32		37	21	13.8	10.6	8	6.8
29 ... 42		34	18.5	12.6	9.5	6.8	6
36 ... 52		43	23.9	16.1	11.8	9	7.3
45 ... 63		37.4	21.3	15.2	10.6	7.6	6.6
60 ... 80		46.7	23	15.7	11.5	7.9	6.7
<b>Thermal overload relays TA110DU ... V1000</b>							
66 ... 90		32	16.7	11.5	8.5	6.3	5.4
80 ... 110		34.5	18.2	12.2	8.8	6.7	5.1
<b>Thermal overload relays TA200DU ... V1000</b>							
66 ... 90		27.7	15.8	10.6	7.9	5.6	4.9
80 ... 110		25.1	14.1	9.7	7.1	5.2	4.5
100 ... 135		24.4	13.3	8.9	6.3	4.6	4
110 ... 150		30	15.8	10.6	7.5	5.6	4.6
130 ... 175		30.1	15.8	11.0	7.5	5.6	5.0
150 ... 200		42.2	21.8	14.5	10.3	7.3	6
<b>Thermal overload relays T450DU ... V1000</b>							
130 ... 185		14.9	8.9	7.1	5.6	4.5	4.2
165 ... 235		18	10	7.1	5.5	4	3.8
220 ... 310		16.8	10	7.1	5.7	4.7	4
285 ... 400		17	10	7.5	5.5	4.3	4
<b>Thermal overload relays T900DU ... V1000</b>							
265 ... 375		16	8.9	7	5.5	4.2	3.8
355 ... 500		17	10.6	7.5	6	4.5	4
465 ... 650		20	11.9	7.9	6	5	4.5
610 ... 850		18.8	11.2	7.9	6	4.7	4.2

# Cross-sections of cables for test

in accordance with VDE 0660, Part 100  
(IEC 947-1) German version EN 60 947-1

Table 1). Copper test conductor for test currents up to 400 A.

Test current range <sup>1)</sup> (A)		Conductor cross-section <sup>2), 3), 4)</sup>	
		(mm <sup>2</sup> )	AWG / MCM
0	8	1,0	18
8	12	1,5	16
12	15	2,5	14
15	20	2,5	12
20	25	4,0	10
25	32	6,0	10
32	50	10	8
50	65	16	6
65	85	25	4
85	100	35	3
100	115	35	2
115	130	50	1
130	150	50	0
150	175	70	00
175	200	95	000
200	225	95	0000
225	250	120	250
250	275	150	300
275	300	185	350
300	350	185	400
350	400	240	500

Table 2). Copper test conductor for test currents over 400 A to 800 A.

Test current range <sup>1)</sup> (A)		Conductor cross-section <sup>2), 3), 4)</sup>			
		metric		MCM	
		Number	Cross-section (mm <sup>2</sup> )	Number	Cross-section (mm <sup>2</sup> )
400	500	2	150	2	250
500	630	2	185	2	350
630	800	2	240	3	300

Table 3). Copper test buses for test currents over 400 A to 3150 A.

Test current range <sup>1)</sup> (A)		Copper buses <sup>2), 3), 4), 5), 6)</sup>		
		Number	Cross-section (mm <sup>2</sup> )	Dimensions (inches)
400	500	2	30 x 5	1 x 0,250
500	630	2	40 x 5	1,25 x 0,250
630	800	2	50 x 5	1,5 x 0,250
800	1000	2	60 x 5	2 x 0,250
1000	1250	2	80 x 5	2,5 x 0,250
1250	1600	2	100 x 5	3 x 0,250
1600	2000	3	100 x 5	3 x 0,250
2000	2500	4	100 x 5	3 x 0,250
2500	3150	3	100 x 10	6 x 0,250

**Footnotes to Tables 1, 2 and 3:**

- 1) The test current must be higher than the first value in the first column and must be lower than or the same as the second value in this column.
- 2) To simplify the testing procedure and with the consent of the manufacturer, conductors with a smaller cross-section than the one determined for the test current may be used.
- 3) The table shows cross-sections of conductors alternatively in the metric system and in the AWG/MCM system and buses in mm and inches. A

comparison of the AWG/MCM system and metric cross-sections is given in Table 1.

- 4) Optionally, either one of the two conductors given for the test current range may be used.
- 5) It is assumed that buses with the larger surface area are arranged vertically. Buses may be arranged horizontally if so directed by the manufacturer.
- 6) If 4 buses are used, they must be arranged in two pairs with a mean clearance of at most 100 mm.











## General technical data

### Approvals and certificates

**Explanation of symbols:**

- Normal version approved: Rating plates bear the test mark if mandatory.
- Special design approved

- Submitted for approval, delivery time on request
- No approval required except in special cases
- △ Submission for approval intended
- ▲ Approved with restrictions

Unit type	Approvals				Ships' classification societies							
Test mark				Phys.- Technische Bundes- anstalt								
Abbreviation valid for	CSA Canada	UL USA	UL USA	PTB Germany	BV France	GL Germany	LRS Great Britain	DNV Norway	PRS Poland	RINa Italy	MRS Russia	

### Thermal overload relays

T7DU	■		■	■	■	□	□					
TA25DU	■		■	■	■	■	■	■	■	△	■	△
TA42DU	■		■	■	■	■	■	■	■	△	■	△
TA75DU	■		■	■	■	■	■	■	■	△	■	△
TA80DU	■		■	■	□	■	□	□	□	△	△	△
TA110DU	■		■	■	□	■	□	□	□	△	△	△
T / TA200DU	■		■	■	■	■	■	■	■	■	■	■
T / TA450DU/SU	■		■	■	■	■	■	■	■ (2)	■	■	■
T900DU/SU	■		■	■	■	■	■	■	■ (2)	■	■	■

(2) except Types SU.

---

# Notes

---

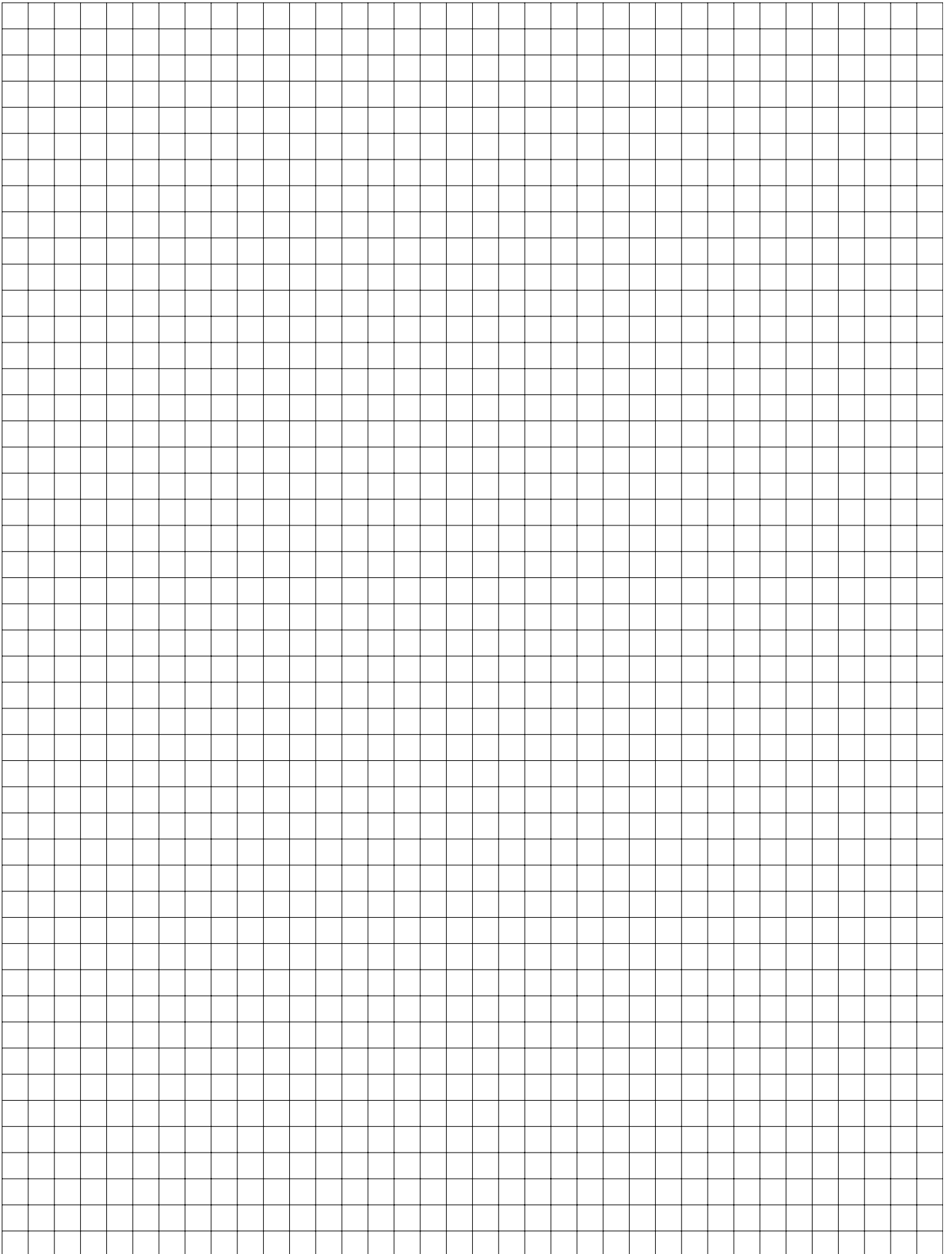



# Electronic overload relay E16DU

## Technical data

### General technical data

Type	E16DU	
<b>Standards:</b> (major European and international standards)	IEC 60947-4-1 / IEC 60947-5-1 EN 60947-4-1 / EN 60947-5-1	
<b>Approvals and certificates</b>	see page 30	
<b>Rated insulation voltage <math>U_i</math></b>	V	690
<b>Rated operating voltage <math>U_e</math></b>	V	690
<b>Impulse withstand voltage <math>U_{imp}</math></b>	kV	6
<b>Permissible ambient temperature</b>	- Storage - Operation	°C °C
		- 25 to +70 - 25 to +70
<b>Climatic resistance according to</b>	IEC 68-2-1, IEC 68-2-2, IEC 68-2-14, IEC 68-2-30	
<b>Mounting position</b>	any	
<b>Resistance to shock</b>	Shock duration ms multiple of g	11 15
<b>Resistance to vibrations</b> (±1 mm, 10 ... 100 Hz)	multiple of g	- 5
<b>Mounting</b>	- onto contactor - with DB.. mounting kit for single set-ups	hooking on contactors, screwing on in main terminals by screws: 2 x M4 or 
<b>Connection terminals and attachment type</b>		
<b>Main conductors (load side)/and auxiliary contacts.</b>		
• Screw terminal (screw size)	M3.5	
- with self-disengaging clamping piece	-	
- with terminal block	-	
- with busbars or cable lugs	-	
• Tightening torque	Nm	1
• Connection cross-sections		
- single-core or stranded	mm <sup>2</sup>	2 x 0.75...4
- flexible with wire end ferrule	mm <sup>2</sup>	2 x 0.75...4
<b>Protection degree</b> to IEC 60947-1/EN 60947-1	All terminals are safe from finger-touch and safe from touch by the back of the hand to VDE 0106, Part 100	

### Technical data of the conducting paths

Type	E16DU	
<b>Number of conducting paths</b>	3	
<b>Setting ranges</b>	see ordering details page 13	
Tripping classes to IEC 60947-4-1/EN 60947-4-1	see ordering details page 13	
<b>Frequency range</b>	Hz	50 and 60
<b>Switching frequency</b> without early tripping	80 ops./h with 40% if the making current does not exceed 6 x I <sub>n</sub> and the starting time does not exceed 1s.	
<b>Resistance per phase in Ω</b> and power loss per phase in W at max. setting current	see page 30	
<b>Required fuses</b> for short-circuit protection	see page 30	

### Load rating of auxiliary contacts

Type	E16DU		
Contact		NC (95-96)	NO (97-98)
<b>Rated operating voltage <math>U_e</math></b>	V	600	600
<b>Rated thermal continuous current</b>	A	6	6
<b>Rated operating current <math>I_e</math></b>			
at AC-15 230 V	A	3	3
at AC-15 400 V	A	1.1	1.1
at AC-15 500 V	A	0.9	0.9
at AC-15 690 V	A	0.7	0.7
at DC-13 24 V	A	1.5	1.5
at DC-13 60 V	A	0.5	0.5
at DC-13 110 V	A	0.4	0.4
at DC-13 220 V	A	0.2	0.2
<b>Short-circuit protection fuse</b> or <b>STOTZ safety circuit-breaker:</b>	gG S271 S281	A	6 (1) (1)

(1) on request

# Electronic overload relays E200DU ... E800DU

## Technical data

### General technical data

Type	E200DU	E320DU	E500DU	E800DU
<b>Standards:</b> (major European and international standards)	IEC 60947-4-1 / IEC 60947-5-1 EN 60947-4-1 / EN 60947-5-1			
<b>Approvals and certificates</b>	see page 30			
<b>Rated insulation voltage <math>U_i</math></b>	V 690			
<b>Rated operating voltage <math>U_e</math></b>	V 690			
<b>Impulse withstand voltage <math>U_{imp}</math></b>	kV 6			
<b>Permissible ambient temperature</b>	°C			
- Storage	- 25 to +70			
- Operation	- 25 to +70			
<b>Climatic resistance according to</b>	IEC 68-2-1, IEC 68-2-2, IEC 68-2-14, IEC 68-2-30		IEC 68-2-1, IEC 68-2-2, IEC 68-2-30	
<b>Mounting position</b>	any			
<b>Resistance to shock</b>	Shock duration ms 30 multiple of g 5			
<b>Resistance to vibrations to EN 61373</b>	category 1, class B			
<b>Mounting</b>	- onto contactor - with DT.. mounting kit for single set-ups - onto panel plate			
	hooking on contactors, screwing on in main terminals by screws: 4 x M5		screwing on in main terminals by screws: 2 x M4 or  by screws: 4 x M6	
<b>Connection terminals and attachment type</b>				
<b>Auxiliary contacts.</b>				
• Screw terminal (screw size) - with self-disengaging clamping piece	M3.5			
• Tightening torque	Nm 1			
• Connection cross-sections				
- single-core or stranded	mm <sup>2</sup> 2 x 0.75...4			
- flexible with wire end ferrule	mm <sup>2</sup> 2 x 0.75...4			
<b>Connection terminals and attachment type</b>				
<b>Main conductors.</b>				
• Screw terminal (screw size)	M8	M10	(M10)	(M12) (rail order separately)
<b>Protection degree to IEC 60947-1/EN 60947-1</b>	All terminals are safe from finger-touch and safe from touch by the back of the hand to VDE 0106, Part 100			

### Technical data of the conducting paths

Type	E200DU	E320DU	E500DU	E800DU
<b>Number of conducting paths</b>	3			
<b>Setting ranges</b>	60 ... 200	100 ... 320	150 ... 500	250 ... 800
Tripping classes to IEC 60947-4-1/EN 60947-4-1	10, 20, 30 eligible			
<b>Frequency range</b>	Hz 50 and 60 (only for a.c. operating 3 phase)			

### Load rating of auxiliary contacts

Type	E200 / E320 / E500 / E800DU			
	NC (95-96)		NO (97-98)	
<b>Contact</b>	NC (95-96)		NO (97-98)	
<b>Rated operating voltage <math>U_e</math></b>	V 600		V 600	
<b>Rated thermal continuous current</b>	A 6		A 6	
<b>Rated operating current <math>I_e</math></b>	A		A	
at AC-15 230 V	3		3	
at AC-15 400 V	1.1		1.1	
at AC-15 500 V	0.9		0.9	
at AC-15 690 V	0.7		0.7	
at DC-13 24 V	1.5		1.5	
at DC-13 60 V	0.5		0.5	
at DC-13 110 V	0.4		0.4	
at DC-13 220 V	0.2		0.2	
<b>Short-circuit protection fuse or STOTZ safety circuit-breaker:</b>	gG A 6		gG A 6	
S271	(1)		(1)	
S281	(1)		(1)	

(1) on request

# UMC22-FBP

## Technical data

### General technical data

Type	UMC22-FBP	
Rated operating voltage $U_e$ (three-phase system) V AC/Hz	max. 690/50	
Rated operating current range	A	0.24 ... 63
Trip classes	5, 10, 20, 30	
Short-circuit-protection	separate fuses on power line side	
Supply voltage	V DC	19.2 ... 31.2, including ripple
Supply current	mA	max. 130 (at 18 ... 30 V DC)
Total device power dissipation	W	max. 3.1 (at 24 V DC)
LEDs on front	LED 1, green: device ready for operation LED 2, yellow: motor current > 33 % of $I_s$ LED 3, red: fault (trip, device fault, etc.)	
Mechanical relay contact lifetime	500 000 switching cycles	
Electrical lifetime	250 V AC / 0.5 A	100 000 switching cycles
	250 V AC / 1.5 A	50 000 switching cycles
Terminal conductor cross section	mm <sup>2</sup>	max. 2.5, max. 2 x 1.5
Current transformer bushing holes	11 mm Ø (25 mm <sup>4</sup> )	
Internal clearance and creepage distances	mm	> 5.5 (safety insulation up to 250 V AC)
Mounting	on DIN rail (EN 50022-35) or wall mounting with 4 screws M4	
Dimensions (W x H x D)	mm	70 x 105 x 110 (incl. FieldBusPlug and Control Panel)
Net weight	kg	0.39 (current transf. + control unit)
Degree of protection	IP 20	
Storage temperature range	°C	-25...+70
Operating temperature range	°C	0...+55
Technical description Order Code	2CDC 135 004 D02xx	
FieldBusPlug connection	see FBP catalogue	

### Digital inputs

Number of digital inputs	6 (DI0 ... DI5)
Power supply for digital inputs	18 ... 30V, 70 mA
1-Signal (range including ripple)	+13 V ... +31.2 V
0-Signal (range including ripple)	-31.2 V ... +13 V
Input current per channel	(24 V DC) typ. 6.0 mA
Input resistor to 0 V	3.9 kOhm
Line length unshielded	max. 600 m
Line length shielded	max. 1000 m

### Digital outputs

Number of digital relay outputs	3 (DO0...DO2)
Grouping of contacts	3 contacts with 1 common
Switching capacity per relay contact	
AC15:	120 V AC, max. 3 A 240 V AC, max. 1.5 A
DC13:	24 V DC, max. 0.1 A 125 V DC, max. 0.22 A 250 V DC, max. 0.11 A
max. load for all contacts	4 A (terminal 5 or 6)
min load for switching signals	12 V, 1 W or 1 VA

### Parameter Options:

- 1 = Control function
- 2 = check back via aux.-contact
- 3 = Fault output, e.g. to lamp
- 4 = Fault signal input, e.g. for thermistor
- 5 = Local control via inputs

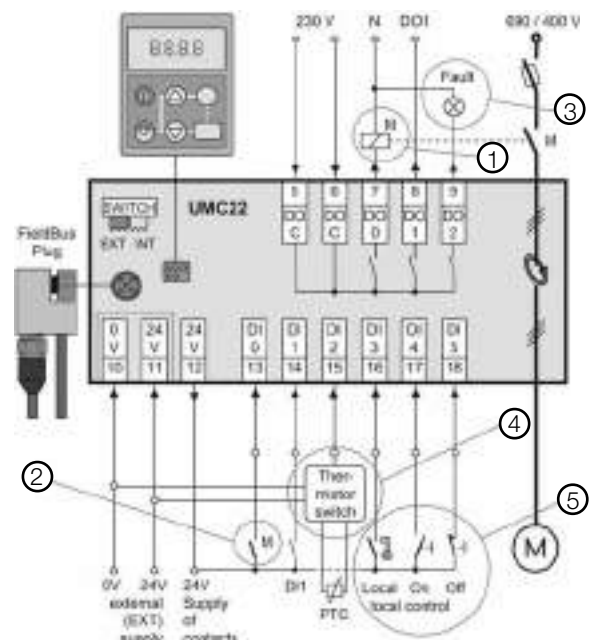

Conductor holes through the current transformers max. 25 mm<sup>2</sup>  
(max. diameter incl. insulation 11 mm)

# Electronic overload relays E16DU, E200DU, E320DU, E500DU, E800DU

## Technical data

### Load rating of auxiliary switches

Type		E200DU, E320DU E500DU, E800DU	
		E16DU	
		NC 95-96	NO 97-98
Rated operating voltage $U_e$	V	600	600
Rated thermal continuous current	A	6	6
Rated operating current $I_e$			
at AC-15 230 V	A	3	3
at AC-15 400 V	A	1.1	1.1
at AC-15 500 V	A	0.7	0.7
at DC-13 24 V	A	1.5	1.5
at DC-13 60 V	A	0.5	0.5
at DC-13 110 V	A	0.4	0.4
at DC-13 220 V	A	0.2	0.2
Short-circuit protection	gG A	6	6
STOTZ safety circuit-breaker: S271 S281		*	*

\* on request

### Notes for applications with frequent starts

In order to avoid overloads, motors must not be operated with just any starting frequency. With frequent start of motors the rated current of the motor doesn't play the decisive part anymore but much rather the higher starting current (typical 6 x the rated motor current) as well as the starting frequency, the start-up time and the power-on time. A periodical operation of the motor is exemplified in the current-/time-curve below:

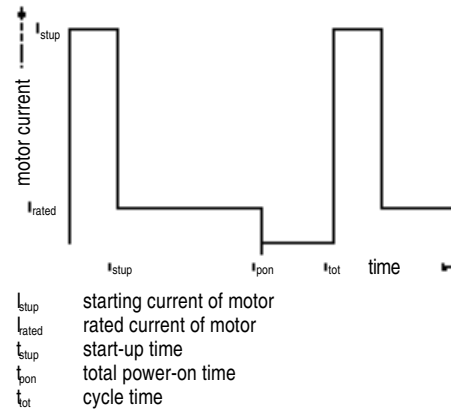

Sometimes calculations are done using the power-on time PT. The value of PT can be deducted as follows:

$$PT = \frac{t_{pon}}{t_{tot}}$$

The electronic overload relay simulates the thermal behaviour of a motor in a model. The tripping threshold of the overload relay is situated at  $(1.125 \pm 0.075) \times$  rated current. The temperature of the motor can have the following characteristics, when it gets started frequently. As shown in this example the mean temperature of the motor stays beneath the permissible maximum temperature, however, on start-up the motor temperature can exceed this temperature barrier. In this case the overload relay trips.

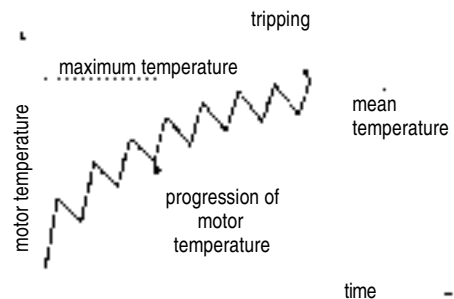

With each start-up, the motor will heat up immensely though for a short time period only (increase in the temperature characteristic of the motor). The heat will distribute itself throughout the motor once the start-up process is finished as well as in breaks when the motor is not running (decrease in the temperature characteristic of the motor). This way the mean temperature of the motor rises. The light curve shows the increase of the mean temperature. To prevent damage to the motor it has to be stopped if the temperature of the motor exceeds the maximum permissible temperature. In this case the overload relay trips.

The tripping curve of the overload relays gives an orientation for the permissible duration of a motor start-up for cases, when due to long power-on times (PT) or due to frequent starts the mean effective value of the current reaches the rated current. The mean effective value  $I_{eff}$  is calculated as follows:

$$I_{eff} = \sqrt{\frac{I_{stup}^2 \cdot t_{stup} + I_{rated}^2 \cdot (t_{pon} - t_{stup})}{t_{tot}}}$$

For overload relays E... the maximum start-up times can be deducted from the curve "warm" for  $I_{eff} \leq I_{rated}$  as an orientation. The start-up times should be 10% under the tripping times of the curve (see table)

### Tripping curves 3-phase for electronic overload relay E ... DU

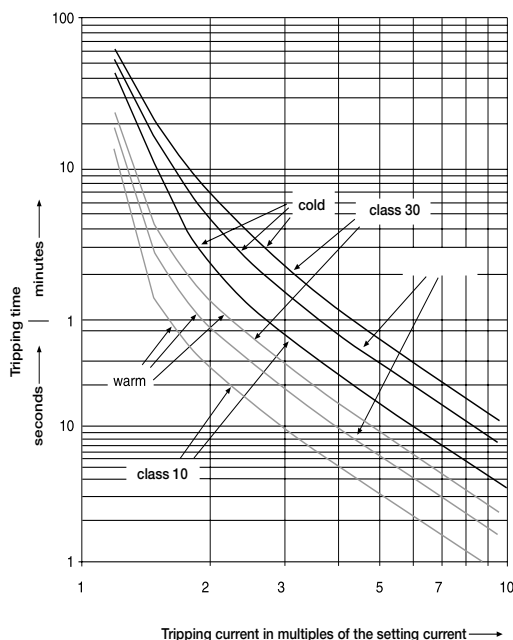

Multiples of rated motor current at start-up	Tripping time class 10 approx. [s]	Tripping time class 20 approx. [s]	Tripping time class 30 approx. [s]
3	8.6	17.2	25.9
4	4.5	9.1	13.5
5	2.8	5.6	8.5
6	1.9	3.9	5.8
7.2	1.4	2.6	3.9
8	1.1	2.2	3.3

# Electronic overload relays E16DU

for contactors and mini contactors

Technical data





## Resistances and power losses

Setting range	Short-circuit protection (fuses, miniature circuit-breakers)			Resistance per phase at upper setting current $\Omega$	Power loss per phase W
A ... A	gL/gG A				

## Electronic overload relay E16DU

0.1 ... 0.32	1				0.97	0.1
0.3 ... 1.00	4				0.113	0.11
0.9 ... 2.70	10				0.014	0.1
2.0 ... 6.30	20				0.0024	0.1
5.7 ... 18.90	50				0.0008	0.29

## Approvals and certificates

Approvals				Ships' classification societies			
		German National Standards Laboratory PTB Ex „e“ *			LRS Great Britain		
UL USA	CSA Canada	Ex „e“ *		GL Germany		BV France	DNV Norway
■	■	□		■	■	■	■
■	■	□		■	■	■	■
■	■	□		■	■	■	■
■	■	□		■	■	■	■
■	■	□		■	■	■	■

■ Normal version approved;  
rating plates bear the test mark if mandatory

□ Submitted for approval

\* Protection of intrinsically safe motors (EN 50019) class Ex "e" to DIN VDE 0165/02.91  
(= Protection of intrinsically safe motors (EN 50019) of enclosure increased safety "e" in accordance with the provisions for "Installation of electrical systems in explosion-hazard areas" to DIN VDE 0165/02.91.)



# Thermal overload relays

## Accessories

## Dimensions

### TA75DU



### TA80DU



\* For TA75DU 80

### TA42DU, TA75DU, TA80DU + DB80

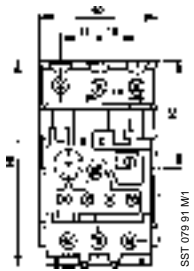

### Drilling plan

(TA42DU, TA75DU und TA80DU + DB80 for single set-up)

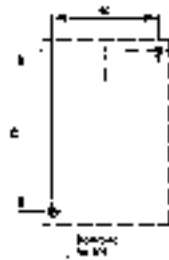

### TA110DU

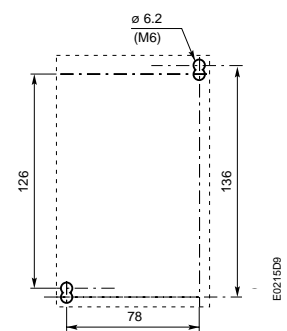
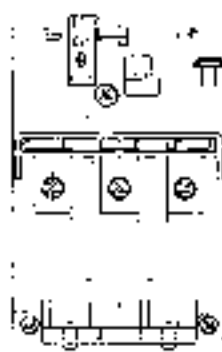
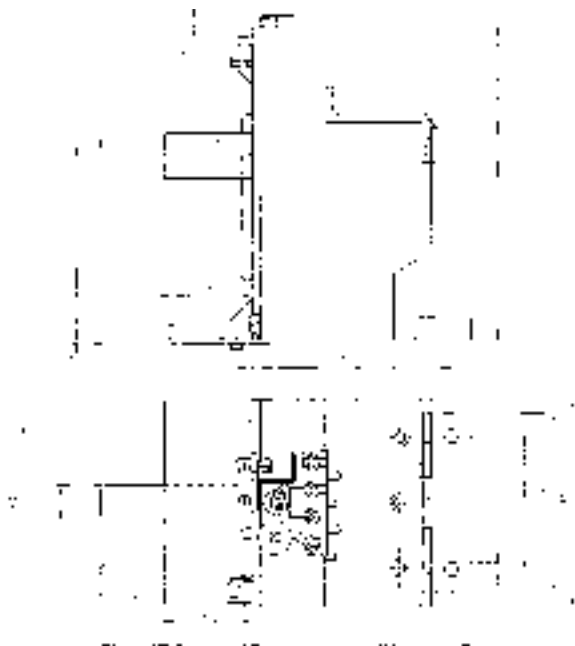

# Thermal overload relays

## Accessories

## Dimensions

### T / TA200DU

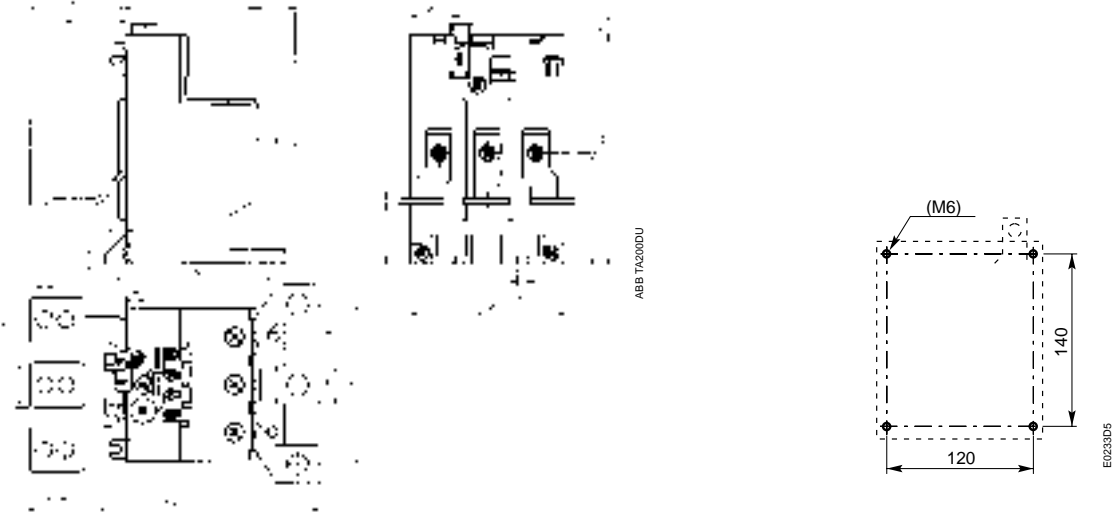

### T / TA450DU/SU

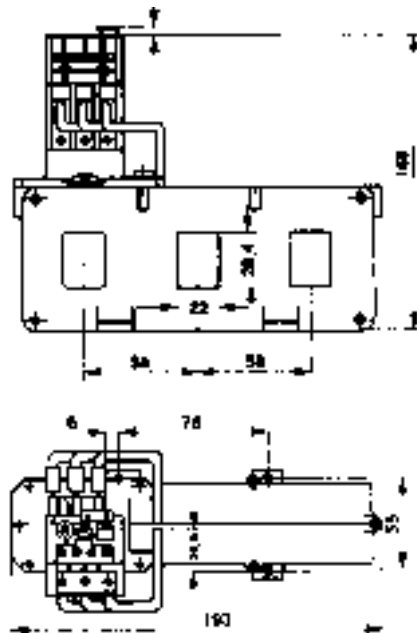

### T900DU/SU

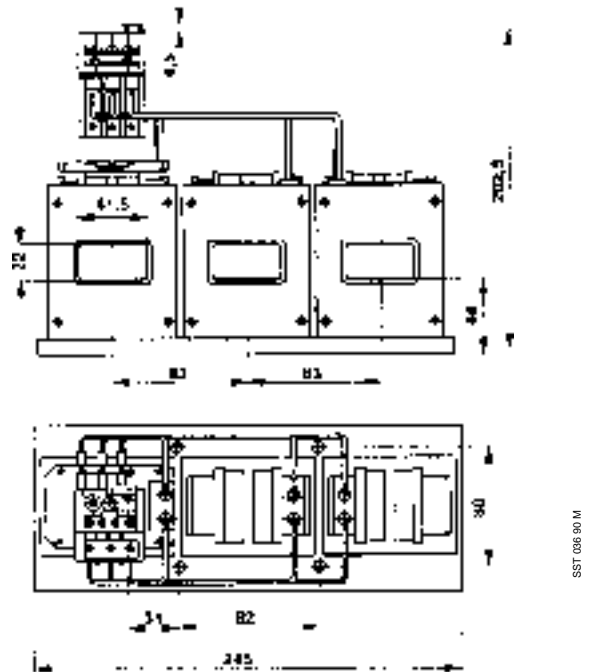

(dimensions in mm)



# Electronic overload relays

## Accessories

## Dimensions

(Dimensions in mm)

E16DU

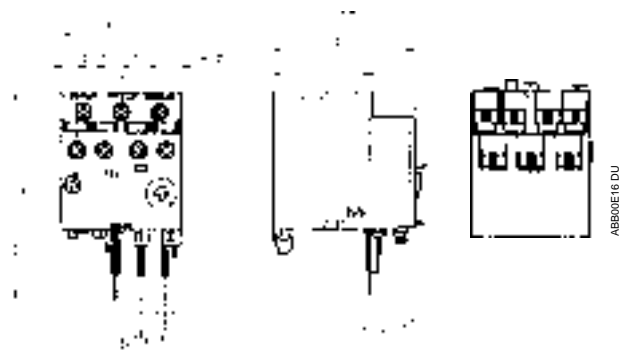

E16DU + DB16E



AF400, AF460 +1 x CAL18  
+ electronic overload relays E500DU

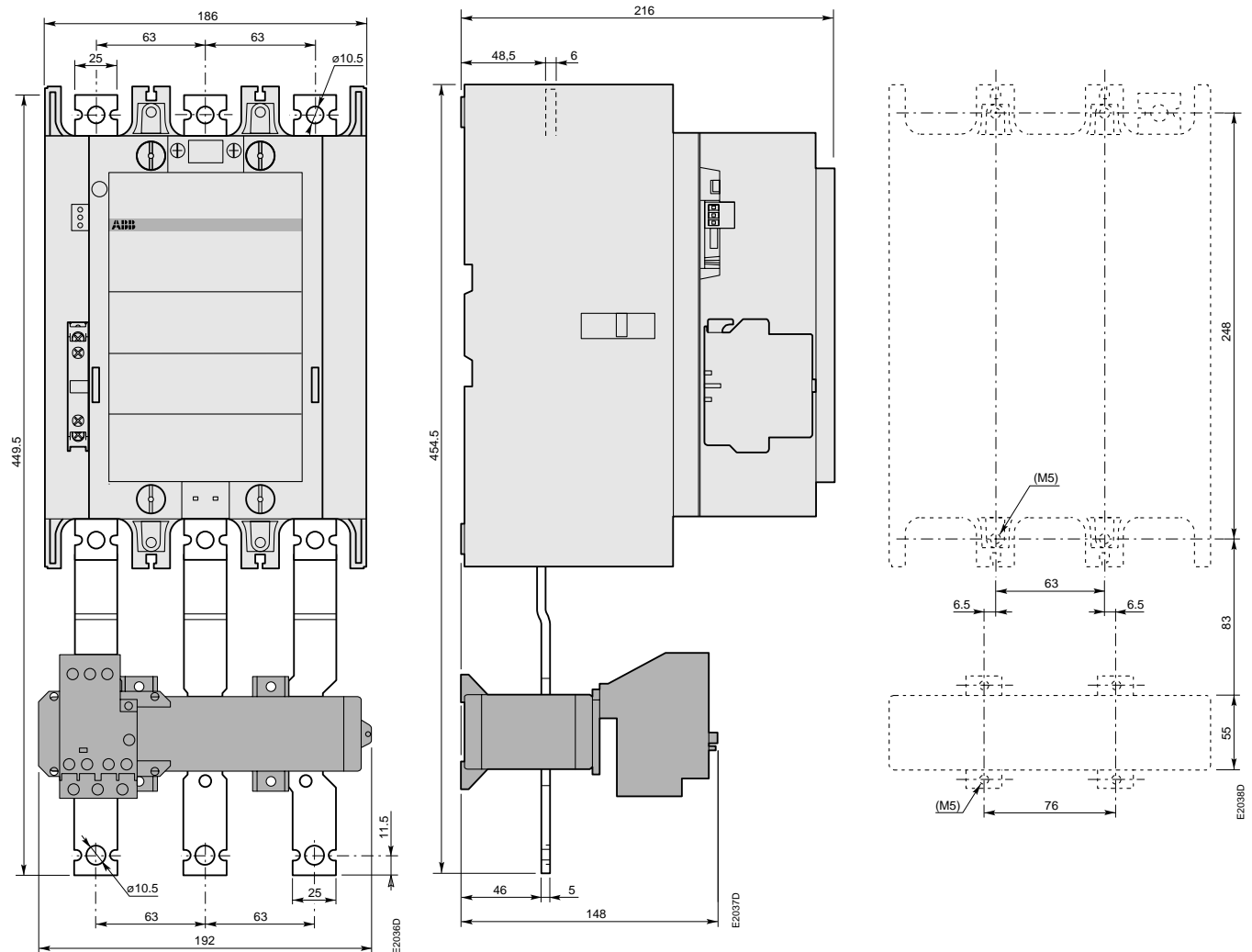

# Electronic overload relays

## Accessories

### Dimensions

(Dimensions in mm)

AF400 / AF460 + E500DU + DT500 / AF460S

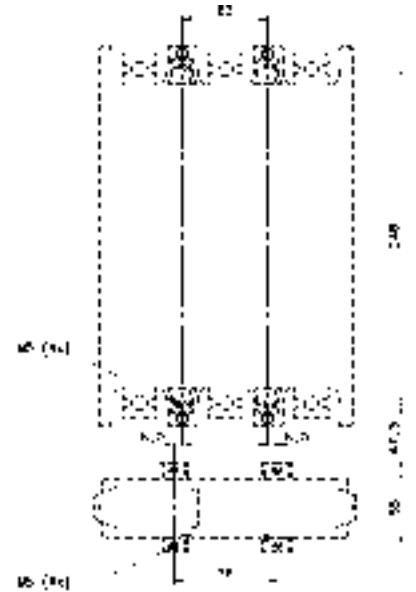
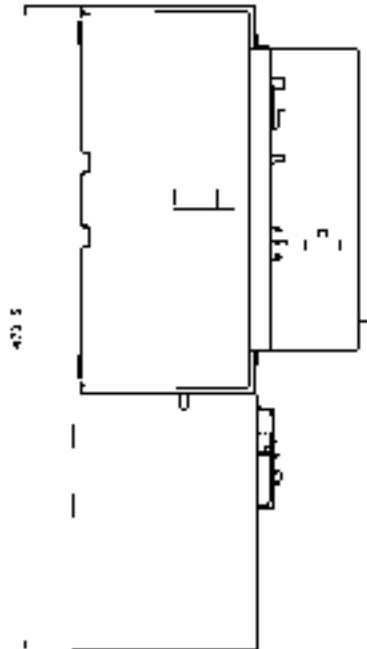
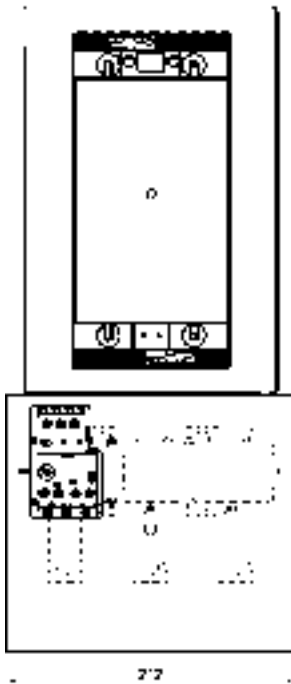

AF400 / AF460 + E500DU + DT500 / AF460L

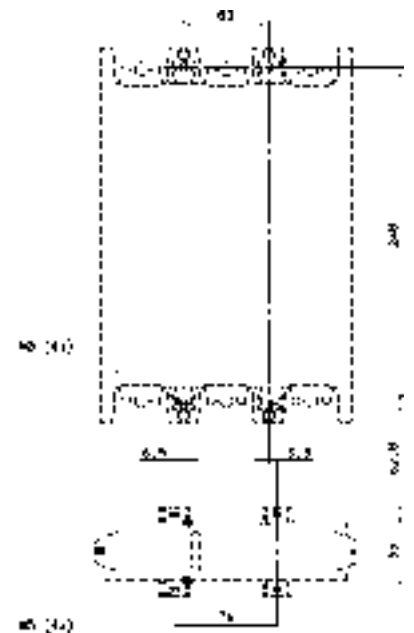
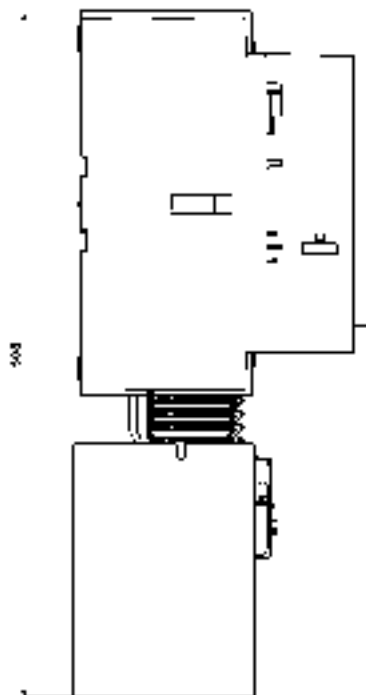
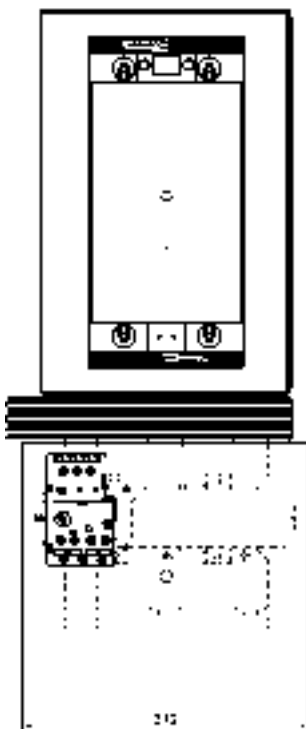

## Technical Catalogue

# Thermal Overload Relays Electronic Overload Relays



Brochure No. 2.CDC.106014C0201 Printed in the Federal Republic of Germany (06.04 · 3 · GVD) subject to modification



ABB STOTZ-KONTAKT GmbH  
P. O. Box 10 16 80  
69006 Heidelberg  
Germany  
Telephone: ++49 62 21 / 701-0  
Telefax: ++49 62 21 / 701-729  
<http://www.abb.de/stotz-kontakt>  
Email: [desst.info@de.abb.com](mailto:desst.info@de.abb.com)

### ABB Global Contact Directory

The ABB Contact Directory (<http://www.abb.com/contacts/>) helps you find local contacts for ABB products in your country. Please select the relevant product group from the dropdown menu to the right or from the page.