









# TP04G-AS2

## Terminal Panels Series Instruction Sheet

### 1 WARNING

-  Please carefully read this instruction before using the TP04G.
-  DANGER! DC input power must be OFF before any maintenance. Do not insert or remove wires and connectors while power is applied to the circuit. Only the qualified technicians are allowed to perform the maintenance.
-  The TP04G display panel is waterproof. But please prevent grease, corrosive liquids and sharp objects from contacting the TP04G.
-  DANGER! The TP04G requires 24VDC input power. The 24VDC input power should not be connected to the RS-485 communication port. The unit may be destroyed or can't be repaired if the input power is improperly applied. Please always check the correctly input power wiring before apply power.
-  DANGER! An electrical charge will remain on the DC-link capacitors for 1 minute after power OFF. This residual power may be hazardous and the TP04G should not be worked on until this charge has dissipated. To prevent injury, do not conduct any wiring or investigation on the TP04G until 1 minute after power has been removed.
-  CAUTION! Always ground the TP04G by using the grounding terminal. Not only this acts as a safety, but also filter out electrical noise. The ground method must comply with the laws of the country where the unit is to be installed.
-  CAUTION! TP04G may be damaged if the fixed support (shipped with the pack) is adjusted too tight.
-  Battery replacement: please use UL component type: CR2030 lithium battery which battery life is 1200 hours after power loss. (NOTE: RTC should be reset after changing battery).

### 2 INTRODUCTION

#### 2.1 Model Explanation

- Thank you for choosing DELTA TP Series. TP04G-AS2 has the features of high resolution 128\*64 to display 8\*4 Chinese characters max, and Multilanguage support.
- Built-in two communication ports so that RS-232 and RS-485/RS-422 can be used simultaneously.
- Built-in RTC and communication/alarm indication LED.
- Possess extension slot for program copy card to copy settings and programs rapidly and save download time.
- Built-in various objects to meet your requirements.
- Nameplate

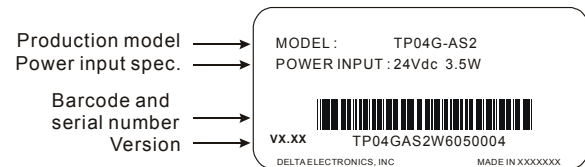

Note: The words of "MADE IN XXXXX" will be different due to the manufacturing location.

#### ■ Model and Serial Number Explanation

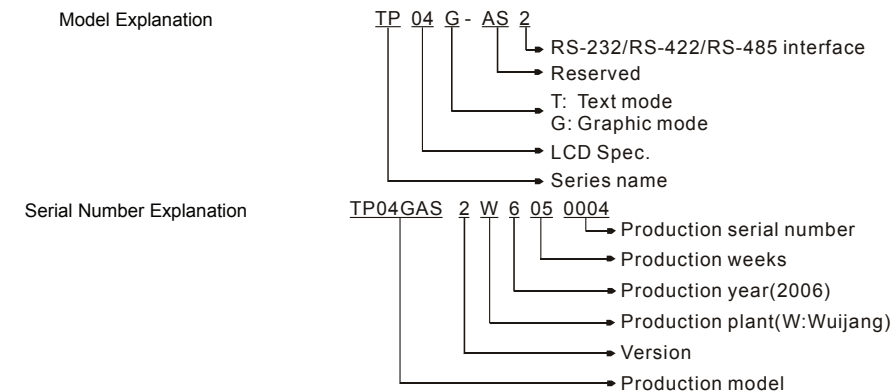

### 2.2 Outline

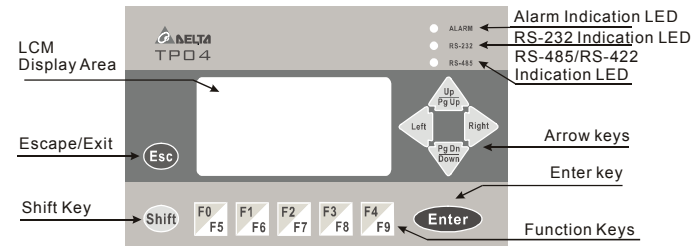

### 2.3 Panel Function Explanation

PANEL COMPONENT	EXPLANATION
Alarm Indication LED (RED)	Status 1: When power is on, LED will blink slowly for three times. Status 2: When there is an abnormal situation, LED will blink quickly along with an alarm sound.
RS-232 Indication LED (Yellow)	LED will blink when transmits program and communicates via RS-232.
RS-485/RS-422 Indication LED (Green)	LED will blink when communicates via RS-485/RS-422.
LCM display Area	Liquid Crystal Module display area used to display current program state.
Escape/Exit	Used to cancel an incorrect input, or to Exit a programming step.
Arrow Keys	<b>UP/Pg Up:</b> Used to increase the value or move up one page. <b>Pg Dn/DOWN:</b> Used to decrease the value or move down one page. <b>Left:</b> Left direction key (move cursor to left). <b>Right:</b> Right direction key (move cursor to right).
Shift Key	Used to select keys F5, F6, F7, F8, F9.
Enter key	Used to input a value or accept a programming command.
Function Keys	F0/F5: used to be constant 0 (F0) and 5 (Shift+F0) when it is in the system menu, user can use it to define functions separately when they are in user page. F1/F6: used to be constant 1 (F1) and 6 (Shift+F1) when it is in the system menu, user can use it to define functions separately when they are in user page. F2/F7: used to be constant 2 (F2) and 7 (Shift+F2) when it is in the system menu, user can use it to define functions separately when they are in user page. F3/F8: used to be constant 3 (F3) and 8 (Shift+F3) when it is in the system menu, user can use it to define functions separately when they are in user page. F4/F9: used to be constant 4 (F4) and 9 (Shift+F4) when it is in the system menu, user can use it to define functions separately when they are in user page.

### 2.4 Back Panel

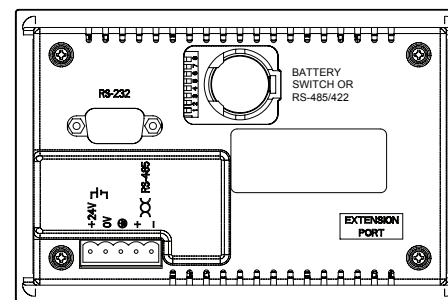

5-PIN terminals: / Wire gauge: 12-24 AWG / Torque: 4.5 lb.-inch

### 2.5 Dimension

Front panel (unit: mm [inch])

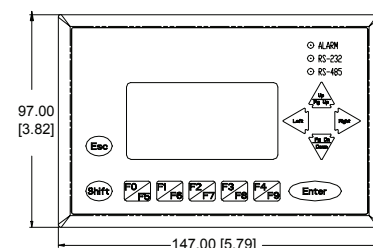

Right side diagram (unit: mm [inch])

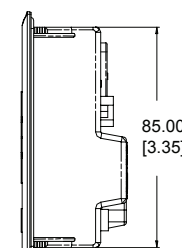

### Back panel

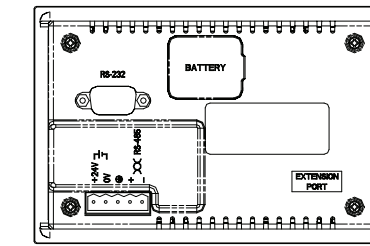

### Mounting dimension (unit: mm [inch])

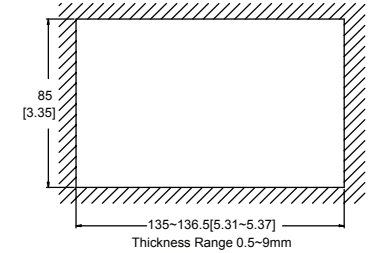

Vertical view (Unit: mm)

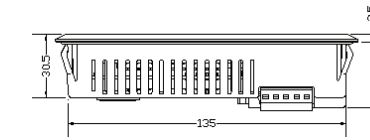

### 2.6 Installation

One easy way is insert TP04G to the opening hole of panel and tight up the screws. However, if a firm mounting TP04G to the panel is needed, please use the fixed support accessory which is packed together with TP04G, then infix the fixed support in the back and tight up the screws. (NOTE: the flat surface should be a Type 4 "Indoor Use Only" enclosure or equivalent.)

 If fixed support is not installed well, Delta will not guarantee the waterproof function. If you turn the screw exceeds torque: 4-5(kg-cm), TP04G could be damaged.

(Note : the flat surface should be a Type 4 "Indoor Use Only" enclosure or equivalent.)

Please leave sufficient space (more than 50mm) around the unit for heat dissipation.

Please leave sufficient space (more than 50mm) around the unit for heat dissipation.

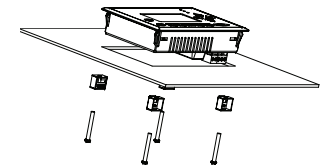
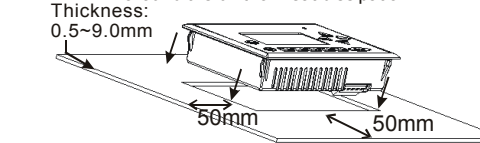

### 3 SPECIFICATION

#### 3.1 Electrical Specification

ITEM	TP04G-AS2
Function Key/Digital Key	F0-F4, ESC, SHIFT, ENTER and ARROW keys
External Input Power	24V (-15%-20%) 3.5W Max.
Memory Capacity	256K Byte
CPU	Hitachi HD64F3064F
RAM of System	32K Byte
Communication Interface	COM1: RS232; COM2: RS485/RS422
Waterproof Class of Front Panel	IP65/NEMA4/UL Type 4 (indoor use)
Environment Condition	0~50°C, relative humidity 20-90% RH (non-condensing)
Storage Temperature for Hardware	-20~60°C
Vibration	1.0G, 10-150Hz, X, Y, Z three directions and 10 sweep cycles per axis
Shock	15G, 11ms, from X, Y, Z three directions and three times for each direction
Radiated Emission	CISPR22, Class A
Electrostatic Discharge Immunity	EN61000-4-2/1995
Radiated Immunity	EN61000-4-3/1995
Electrical Fast Transient	EN61000-4-4/1995
Weight/Dimension	0.24kg/147×97×35.5mm (Width × Height × Deep)
Cooling Method	Natural Air Cooling
Pollution Degree	2
Altitude	2000 m or lower

### 3.2 Function Specification

ITEM	TP04G-AS2	
Screen	STN-LCD	
Color	Monochromatic	
Backlight	The back-light automatic turn off time is 1~99 minutes (0 = do not turn off) (back-light life is about 50 thousand hours at 25°C)	
Resolution	128X64 Points	
Display Range	72mm (W) X 40mm (H); 3.00" (diagonal preferred)	
Contrast Adjustment	10-step contrast adjustment	
Font	ASCII: characters (including European Fonts) Taiwan: (BIG 5 code) traditional Chinese character font China: (GB2324-80 code) simplified Chinese character font	
Maximum words x rows, for each font size	5X 8: 25 words X 8 rows	
	8X8: 16 words X 8 rows	
	8X12: 16 words X 5 rows	
Font Size	8X16: 16 words X 4 rows	
	ASCII: 5X8, 8X8, 8X12, 8X16	
Alarm Indication LED (RED)	1. Power on indication (blink for three times) 2. Will blink for communication error or other alarm 3. Special Indication by user programming	
RS-232 Indication LED (Yellow)	It will blink when transmitting program and communicating by using RS-232.	
RS-485/RS-422 Indication LED (green)	It will blink when communicating by using RS-485/RS-422.	
Program Memory	256KB flash memory	
External Interface	Serial Communication Port RS-232 (COM1)	Unsynchronized transmission method: RS-232 Data length: 7 or 8 bits, Stop bits: 1 or 2 bits Parity: None/Odd/Even, Transmission speed: 9600bps~115200bps RS-232: 9 PIN D-SUB male
	Extension Communication Port RS-422/RS-485 (COM2)	Unsynchronized transmission method: RS-485/RS-422 Data length: 7 or 8 bits, Stop bits: 1 or 2 bits Parity: None/Odd/Even Transmission speed: 9600bps~115200bps RS-422: 9 PIN D-SUB male RS-485: 5-Pin removal terminal
	Extension Slot	1. Update program version 2.The slot for program copy card
	Battery Cover	DC 3V battery for HMI
	5-Pin Removal Terminal	There are DC 24V input and RS-485 input

### 4 PROGRAM COPY CARD

TP04G provides function of program copy card to copy user program, system function and passwords that is different from the copy program. It is used to copy the whole HMI environment settings and application programs to another HMI rapidly. It saves time and manpower. The operation is as follows.

Definition: Program Copy Card →PCC, TP Series →TP

Step	TP→PCC	PCC→TP
1	Turn the switch on the PCC to TP→PCC	Turn the switch on the PCC to PCC→TP
2	Insert the PCC into the extension slot of TP	Insert the PCC into the extension slot of TP
3	Input the power to TP	Input the power to TP
4	It will display "remove PCC" on the screen and power on again	It will display "remove PCC" on the screen and power on again

HMI display message

Copy HMI program to PCC (TP→PCC)	Copy PCC program to HMI (PCC→TP)
If the TP model type does not correspond with the model type of program of PCC, TP will display "TP series and PCC is different. Press Enter to Confirm TP series→PCC. Press Esc to Exit".	If there is no program in PCC, TP will display "The PCC is Empty. PCC→TP series is illegal".
TP will display "TP →PCC series Please wait!" during transmission.	TP will display "TP →PCC series Please wait!" during transmission.
TP will display "Please Remove the PCC and Reboot" when transmit complete.	TP will display "Please Remove the PCC and Reboot" when transmit complete.

### 5 PASSWORD FUNCTION

1. If you forgot the password, it can be cleared by using the following code: **8888**. This universal code will clear the password and all TP04 internal programs. The TP04 will be reset to the factory settings.

2. Users may use 0~9 and A~Z as characters for the password. But it must use the function keys F0~F4 to input the password characters.

F0/F5: scrolls in a loop as follows 0 → 5 → A → B → C → D → E → F → 0

F1/F6: scrolls in a loop as follows 1 → 6 → G → H → I → J → K → 1

F2/F7: scrolls in a loop as follows 2 → 7 → L → M → N → O → P → 2

F3/F8: scrolls in a loop as follows 3 → 8 → Q → R → S → T → U → V → 3

F4/F9: scrolls in a loop as follows 4 → 9 → W → X → Y → Z → 4

### 6 HARDWARE OPERATION

After power supplies to TP04G, the alarm indication LED will blink for three times and startup display, on the LCM display area will show "No User Data in Memory, Press ESC 5 seconds, Return to System".

The steps to Startup the TP04G:

1. Connect power line,
2. Apply 24V DC power,
3. Enter into the startup display,
4. Enter the user-designed program,
5. Press Esc key and hold on for 5 seconds to return to system menu.

There are five selections in the system menu and are described below.

SELECTIONS	EXPLANATION
Download Program	Use the connection cable (DVPACAB530) to connect the TP04 serial communication port RS-232 to a PC. Then use the TPEdit software to download an application program to TP04.
Upload Program	Use the connection cable (DVPACAB530) to connect the TP04 serial communication port RS-232 to a PC. Then use the TPEdit software to upload an application program from TP04.
Copy Program	Transfer a program between two TP04 units. 1: transmit programs 2: receive programs When transmit programs and data between two TP04 units. Set one TP04 to "Receive Program" mode and the other TP04 to "Transmit Program" mode. Please use twisted pair wires to connect the two units via the RS-485 ports.
TP04 Settings	There are 9 items that used to modify TP04 system settings: 1. Communication protocol: Setting the address of TP04, the control port of PLC, and the communication string for either RS-232 or RS-485. 2. Contrast: Adjust the contrast of LCM display screen. 3. Back-light: adjust the automatic turn off time of LCM. Setting range is 00~99 seconds. If set to 00, the LCM Back-light will not turn off. 4. Date and Time: It is used to set the TP04 built-in RTC including year, month, day, hour, minute, second and week. Also the internal battery capacity display is shown here. 5. Buzzer: Used to set the buzzer sound, normal mode or quiet mode. 6. Language Setting: Used to set the displayed language. English, Traditional Chinese, simplified Chinese or user defined language. 7. Password setting: Used to set, enable, and disable the password function. If the password function is enabled, it will require the user to input a password before entering any system menu. The factory password is <b>1234</b> . 8. Startup display: Used to select the TP04 startup display. User can select "user defined" to use the file that designed by TPEdit and download to TP04. 9. Comm. indicator: The user can determine if the RS-232 and RS-485 LEDs will blink or not during communication.
PLC Connection	There are three methods to connect to PLC: 1. Using TP04 serial communication port (COM1) RS-232: set 8-pin DIP switch to RS-485 mode and connect the cable (DVPACAB215 or DVPACAB230) to program communication I/O RS-232C of PLC. 2. Using extension communication port (COM2): set 8-pin DIP switch to RS-485 mode and connect 5-pin removal terminal of extension communication port to RS-485 of PLC with twisted pair. 3. Using extension communication port (COM2): set 8-pin DIP switch to RS-422 mode and connect four pins (6, 7, 8, 9) of 9 PIN D-SUB male to RS-422 of PLC with 4-wire cable.
Execution	Execute the internal program that download from TPEdit or transmitted from other TP04 units. When program is in execution, you can return to system menu by pressing Escape/Exit (Esc) key for 5 seconds.

### 7 COMMUNICATION CONNECTION

TP04G may connect to a PC by using connection cable DVPACAB530

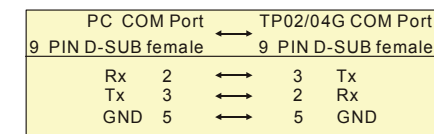
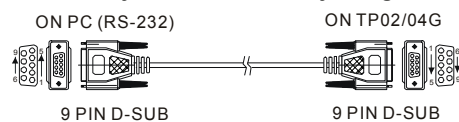

TP04G may connect to a DVP-PLC by using connection cable DVPACAB215/ DVPACAB230 / DVPACAB2A30

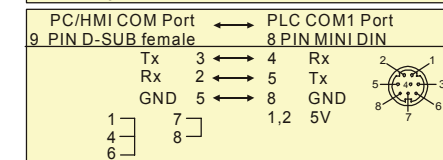
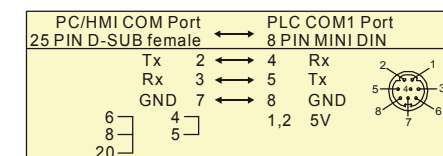
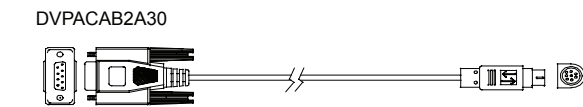
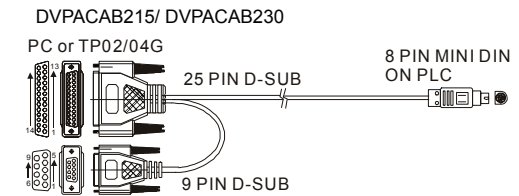

The Pin definition of 9 PIN D-SUB

1. RS-232

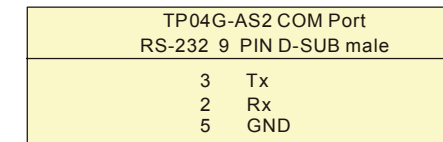

2. RS-422

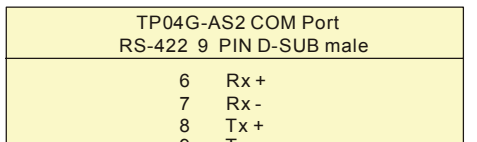

DVPACAB630 (RS-422)

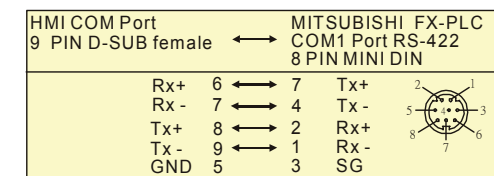
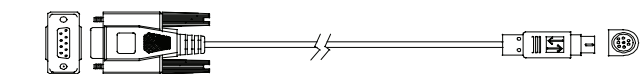

Switch between RS-422 / RS-485 (by using 8-PIN DIP switch)

8-PIN DIP switch	RS-485	RS-422
SW1~SW4	On	Off
SW5~SW8	Off	On

### 8 BATTERY LIFE AND PRECISION OF CALENDAR TIMER

Battery life

Temperature (°C)	-20	0	20	60
Life (year)	1.972	2.466	2.712	2.835

Precision of calendar timer

At 0 °C/32 °F, less than -117 seconds error per month.

At 25 °C/77 °F, less than 52 seconds error per month.

At 55 °C/131 °F, less than -132 seconds error per month.