



Automation for a Changing World

Delta Power Meter DPM Series



www.deltaww.com



DELTA
Smarter. Greener. Together.

Delta Power Meter

DPM Series

The DPM Series precisely measures various electrical energy and power quality parameters, including power factors, harmonics, and current/voltage unbalance. This series also features a variety of communication protocols for easy integration with critical power systems and monitoring functions to provide power data, off-limit alarms, and history logs.

Panel Mount Type DPM-C Series



- Real-time data display and easy integration with remote monitoring systems, suitable for general applications in machine rooms

Applications

Distribution board | Electrical room |
Factory/Building energy management system

DIN Rail Mount Type DPM-D Series



- Easy installation and integration for equipment energy management

Applications

High power consuming equipment |
Electrical equipment cabinet | Enclosure

Multi-Loop Type DPM-M Series



- Multiple and selective large-scale circuit monitoring with lots of power circuits to save cost

Applications

Shopping mall | Dormitory | Telecommunication System

High Precision Power Measurement

- Precise measurement of bidirectional electrical energy and power parameters, meeting IEC 62053-22 standards

Built-in Protocols for Easy Integration

- Built-in RS-485 communication port supports Modbus for transmission of all measurement values to the PLCs, PCs and monitoring software

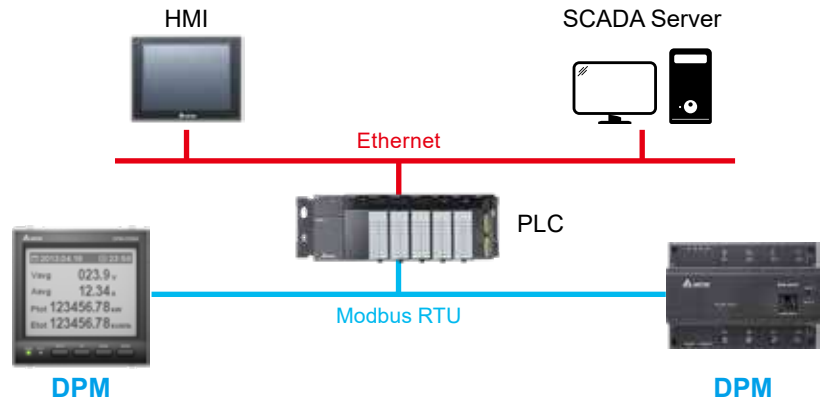

PC-based Configuration Software

- The power meter configuration software DPMSOFT collects electricity data and sets up meters via Modbus communication, achieving easy power management and analysis

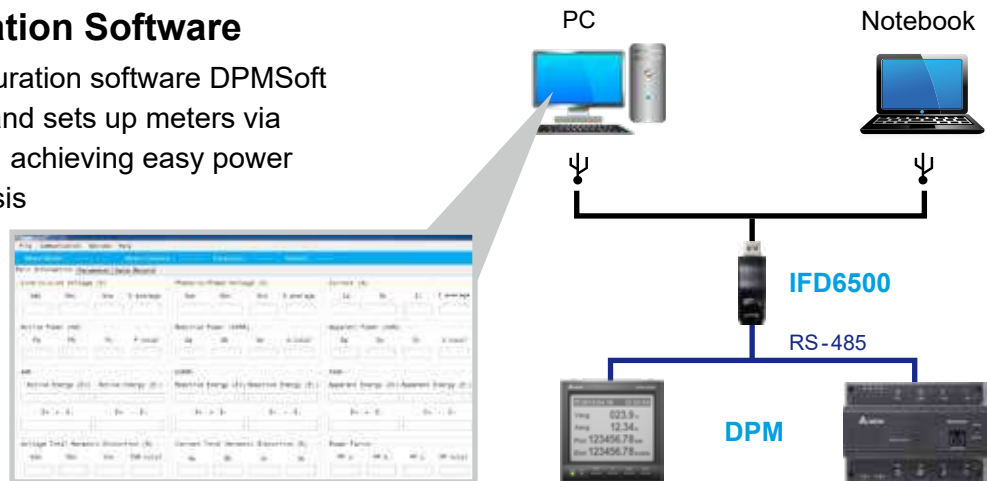

User-defined Parameter Groups

- Allows user-defined Modbus addresses to multiple corresponding parameters for the host computer to acquire data at one time and enhance efficiency

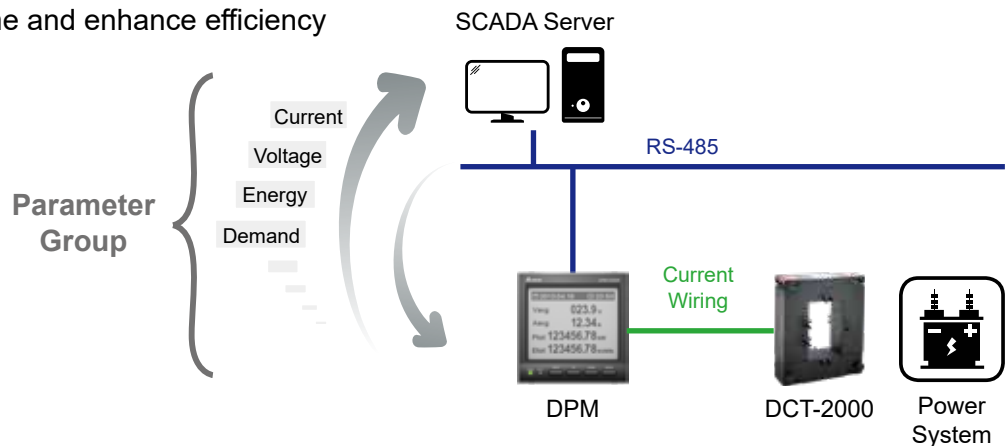

Panel Mount Type

DPM-C Series

- Suitable for applications in general power systems
- Large LCD displays power data in real time
- A variety of communication protocols for easy integration
- Various power monitoring functions for different applications

Applications

Distribution board | Electrical room |
Factory/Building energy management system



Features

Multi-Language Display

- Large dot matrix LCD (198x168 dots), high font recognition
- Multi-language display: English (capital and small letters), Chinese, Japanese and other languages



DPM-C530: dot matrix LCD for high recognition display, better than segment LCD display

Ptot 123456.78 kW
Etot 123456.78 kVARh



Event Alarms and History Logs

- Keeps max. 2 months of electricity measurement values for analysis;
up to 17 power parameters selectable for recordings of different time intervals (e.g. recording 17 electricity parameters every 5 minutes for up to 2 months);
29 types of built-in alarms and up to 500 alarms recording

| Interval | 0~59 secs. | 1~5 mins. | 5~60 mins. |
|---------------------------------|------------|-----------|------------|
| Capacity | | | |
| Max. Data Types | 6 | 17 | 17 |
| Max. Storage Time (Days) | 7 | 31 | 62 |

Auto-Recording

- Automatic calculation of monthly energy consumption
- Allows users to setup specific dates for monthly calculation



Multi-Tariff

- Automatic measurement & calculation of power consumption during a specific time period
- Multiple interval groups setting to measure power consumption at different periods of time

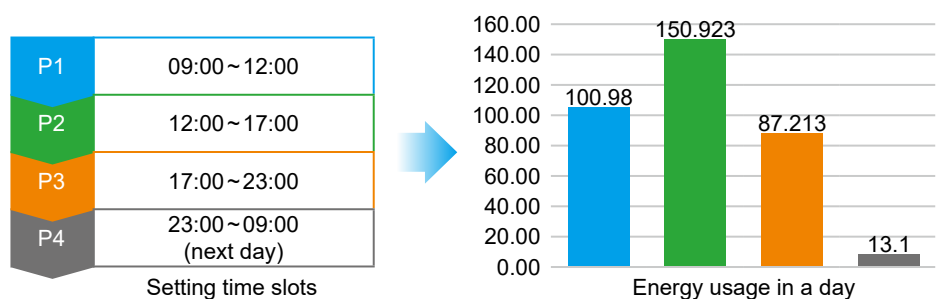

Ethernet Communication

- Dual Ethernet protocols support Modbus TCP
- Easy serial connection without gateway, no need to occupy communication ports
- Basic settings and data viewing on web page

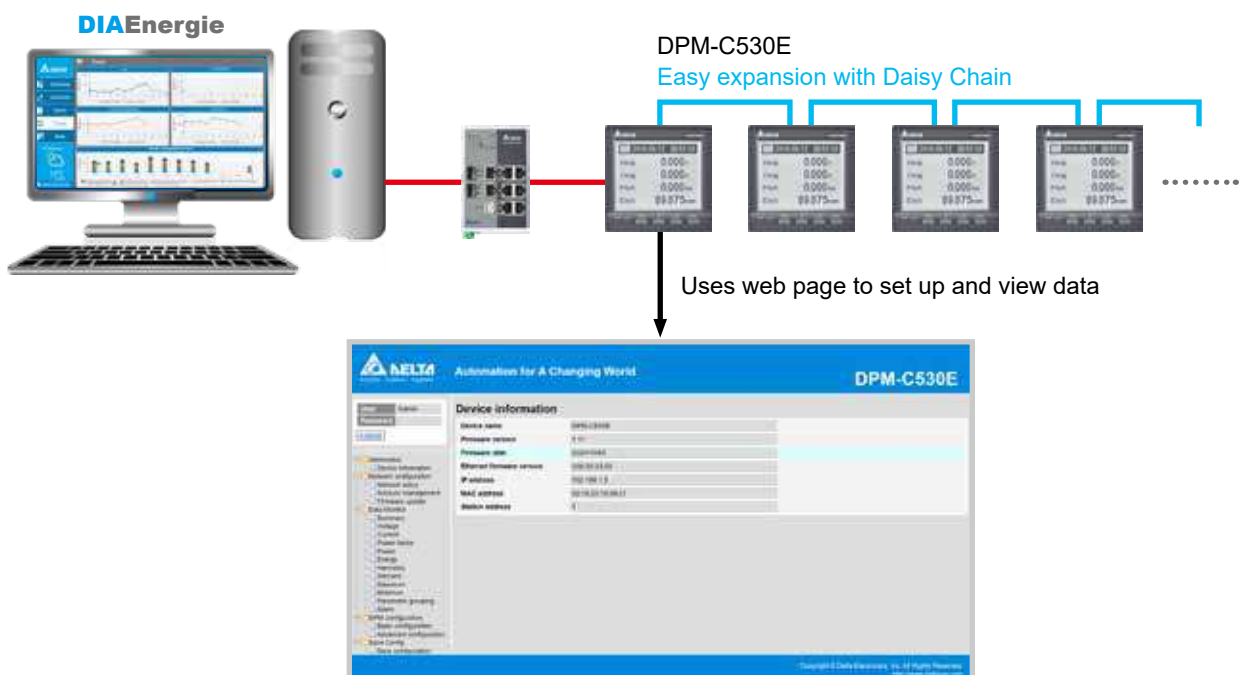

WiFi

- WiFi transmission
 - Reduced wiring cost and time
 - High-speed data exchange and data transmission capability (faster than RS-485)
 - Highly secure wireless data exchange
- No wiring limit, reduces cost and manpower for wiring

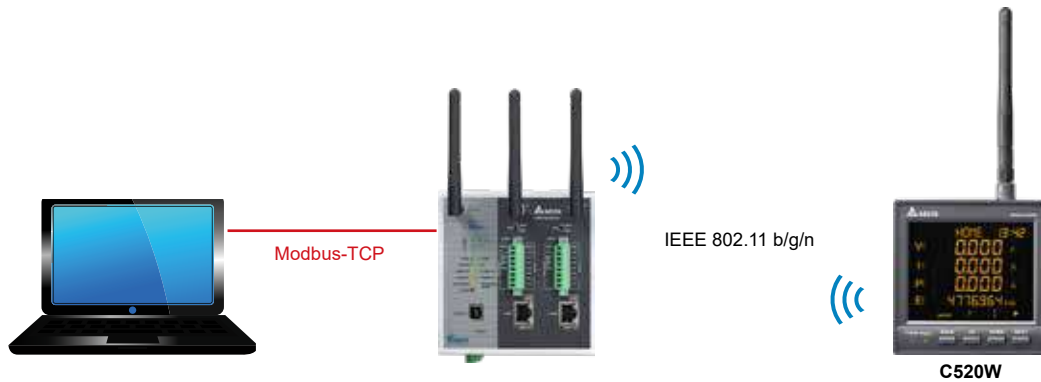





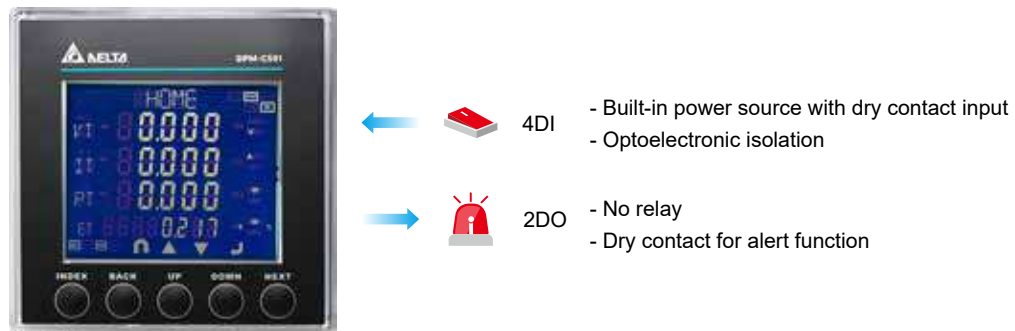

DI/DO Digital Input and Output Functions

- Adopts built-in power source to input alert signals with dry contact and save wiring cost; the optoelectronic isolation functions ensure cable safety
- Offers normal open (NO) relay and dry contact (2A/30V_{DC} or 2A/250V_{AC}) for output broadly applied in alert control output



DMP-C Series Information

| Model | DPM-C530 | DPM-C530E | DPM-C520 | DPM-C520W |
|-----------------------------------------------|-----------------------------------------------------------------------------------|-----------------------------------------------------------------------------------|-------------------------------------------------------------------------------------|-------------------------------------------------------------------------------------|
| Product Appearance |  |  |  |  |
| Front Panel Dimensions | 96x96 mm | 96x96 mm | 96x96 mm | 96x96 mm |
| Accuracy Class | | | | |
| Active Energy (IEC 62053-22) | Class 0.5S | Class 0.5S | Class 0.5S | Class 0.5S |
| Instantaneous Measurement | | | | |
| Current | ● | ● | ● | ● |
| Voltage | ● | ● | ● | ● |
| Frequency | ● | ● | ● | ● |
| Active, Reactive and Apparent Power | ● | ● | ● | ● |
| Power Factor | ● | ● | ● | ● |
| Active, Reactive and Apparent Energy | ● | ● | ● | ● |
| Demand Value | | | | |
| Current | ● | ● | | |
| Power | ● | ● | | |
| Calculation Mode | Fixed Block | Sliding Block/Fixed Block | | |
| Power Quality Analysis | | | | |
| Current/Voltage Unbalance | ● | ● | ● | ● |
| Total Harmonic Distortion (Current/Voltage) | ● | ● | ● | ● |
| Individual Current/Voltage Harmonics | 31 st | 31 st | | |
| Advanced Function | | | | |
| Max./Min. Instantaneous Values with Timestamp | ● | ● | ● | ● |
| Alarm Function | ● | ● | ● | ● |
| Alarm Condition | 29 | 29 | 10 | 10 |
| Alarm Logs | ● | ● | | |
| Data Logs | ● | ● | | |
| User-defined Modbus Address | 35 | 35 | 5 | 5 |
| Monthly Energy Usage | ● | ● | | |
| Multi-Tariff (Section number) | 8 | 8 | | |
| Multi-Language UI | Chinese/English/Japanese | Chinese/English/Japanese | | |
| I/O | | | | |
| Digital Input | | | | |
| Relay | | | | |
| Communication | | | | |
| RS-485 | ● | | ● | ● |
| Ethernet | | ● (2 ports) | | |
| Modbus | RTU/ASCII | TCP | RTU | RTU/TCP |
| BACnet MS/TP | ● | | | |
| WiFi (802.11 b/g/n) | | | | ● |

| Model | DPM-C320 | DPM-C501L | DPM-C502 |
|-----------------------------------------------|-----------------------------------------------------------------------------------|------------------------------------------------------------------------------------|-------------------------------------------------------------------------------------|
| Product Appearance |  |  |  |
| Front Panel Dimensions | 72x72 mm | 96x96 mm | 96x96 mm |
| Accuracy Class | | | |
| Active Energy (IEC 62053-22) | Class 0.5S | 0.5% | 0.5% |
| Instantaneous Measurement | | | |
| Current | ● | ● | ● |
| Voltage | ● | ● | ● |
| Frequency | ● | ● | ● |
| Active, Reactive and Apparent Power | ● | ● | ● |
| Power Factor | ● | ● | ● |
| Active, Reactive and Apparent Energy | ● | ● | ● |
| Demand Value | | | |
| Current | | | |
| Power | | | ● |
| Calculation Mode | | | Sliding Block |
| Power Quality Analysis | | | |
| Current/Voltage Unbalance | ● | ● | ● |
| Total Harmonic Distortion (Current/Voltage) | ● | ● | ● |
| Individual Current / Voltage Harmonics | | | 31 st |
| Advanced Function | | | |
| Max./Min. Instantaneous Values with Timestamp | ● | ● | ● |
| Alarm Function | ● | ● | ● |
| Alarm Condition | 10 | 10 | 10 |
| Alarm Logs | | | |
| Data Logs | | | ● |
| User-defined Modbus Address | 5 | 5 | 5 |
| Monthly Energy Usage | | | |
| Multi-Tariff (Section number) | | | 4 |
| Multi-Language UI | | | |
| I/O | | | |
| Digital Input | | 4 | 4 |
| Relay | | 2 | 2 |
| Communication | | | |
| RS-485 | ● | ● | ● |
| Modbus | RTU | RTU | RTU |

Technical Specifications

| Model | DPM-C530 | DPM-C530E | DPM-C520 | DPM-C520W |
|--------------------------------------|------------------------------------------------------------------------------------------------------------------|------------------------------------------------------------------------------------------------------------------|---------------------|--------------------------------------------------------------|
| Measurement Accuracy | | | | |
| Current | ± 0.5% | ± 0.5% | ± 0.5% | ± 0.5% |
| Voltage | ± 0.5% | ± 0.5% | ± 0.5% | ± 0.5% |
| Active Energy | IEC 62053-22 Class 0.5S | | | |
| Reactive Energy | ± 1% | ± 1% | ± 1% | ± 1% |
| Apparent Energy | ± 2% | ± 2% | ± 2% | ± 2% |
| Active Power | ± 0.5% | ± 0.5% | ± 0.5% | ± 0.5% |
| Reactive Power | ± 1% | ± 1% | ± 1% | ± 1% |
| Apparent Power | ± 2% | ± 2% | ± 2% | ± 2% |
| Power Factor | ± 0.5% | ± 0.5% | ± 0.5% | ± 0.5% |
| Frequency | ± 0.5% | ± 0.5% | ± 0.5% | ± 0.5% |
| Input | | | | |
| Measuring System Type | 1P2W, 1P3W, 3P3W, 3P4W | | | |
| Voltage | 35 V _{AC} ~ 690 V _{AC} (L-L) 20 V _{AC} ~ 400 V _{AC} (L-N) | | | |
| Current | 1A/5A | | | |
| Frequency | 45 ~ 70Hz | | | |
| Control Power | AC: 100 ~ 240V (max. power consumption 4.6W) DC: 100 ~ 300V | | | |
| Data Record | | | | |
| Max./Min. Value | ● | ● | ● | ● |
| Alarm Status & Timestamp | ● | ● | ● | ● |
| Alarm Counting | ● | ● | ● | ● |
| Alarm Logs | 500 | 500 | | |
| Data Logs | Up to 17 parameters with configurable interval & duration (e.g. 17 parameters for 30 days at 1 minute intervals) | Up to 17 parameters with configurable interval & duration (e.g. 17 parameters for 30 days at 1 minute intervals) | | |
| Customizable Data Logs | ● | ● | | |
| Communication | | | | |
| Protocol (Interface) | Modbus RTU/ASCII (RS-485) BACnet MS/TP (RS-485) | Modbus TCP (Ethernet) | Modbus RTU (RS-485) | Modbus RTU (RS-485) / Modbus TCP (WiFi, IEEE802.11 b/g/n) |
| Mechanical Design | | | | |
| IP Rating - Front Panel | IP52 | | | |
| IP Rating - Case | IP20 | | | |
| Dimensions (W x H x D, mm) | 96 x 96 x 95.4 | 96 x 96 x 127.5 | 96 x 96 x 95.4 | 96 x 96 x 95.4 |
| Operating Environment | | | | |
| Operating Temperature | -20 °C ~ +60 °C | | | |
| Storage Temperature | -30 °C ~ +70 °C | | | |
| Relative Humidity | ~ 95% RH | | | |
| Altitude | Below 2,000 meters | | | |
| Electromagnetic Compatibility | | | | |
| Electrostatic Discharge | IEC 61000-4-2 | | | |
| Immunity to Radiated Fields | IEC 61000-4-3 | | | |
| Immunity to Fast Transients | IEC 61000-4-4 | | | |
| Immunity to Impulse Waves | IEC 61000-4-5 | | | |
| Conducted Immunity | IEC 61000-4-6 | | | |
| Immunity to Magnetic Fields | IEC 61000-4-8 | | | |
| Immunity to Voltage Dips | IEC 61000-4-11 | | | |
| Radiated Emissions | FCC Part 15, EN 55011 Class A | | | |
| Conducted Emissions | FCC Part 15, EN 55011 Class A | | | |
| Harmonics Emissions | IEC 61000-3-2 | | | |
| Flicker Emissions | IEC 61000-3-3 | | | |
| Certification | | | | |
| Safety | UL/CE/RCM | UL/CE | | |
| Accuracy | IEC 62053-22/CMA | | | |
| WiFi | | | | CE/FCC/JRF/KCC/ NCC/NTC/IC |

| Model | DPM-C320 | DPM-C501L | DPM-C502 |
|--------------------------------------|------------------------------------------------------------------------------------------------|---------------------|---------------------------------------------------------------------------------------------------------------|
| Measurement Accuracy | | | |
| Current | ± 0.5% | ± 0.5% | ± 0.5% |
| Voltage | ± 0.5% | ± 0.5% | ± 0.5% |
| Active Energy | IEC 62053-22 Class 0.5S | ± 0.5% | ± 0.5% |
| Reactive Energy | ± 1% | ± 1% | ± 1% |
| Apparent Energy | ± 2% | ± 2% | ± 2% |
| Active Power | ± 0.5% | ± 0.5% | ± 0.5% |
| Reactive Power | ± 1% | ± 1% | ± 1% |
| Apparent Power | ± 2% | ± 2% | ± 2% |
| Power Factor | ± 0.5% | ± 0.5% | ± 0.5% |
| Frequency | ± 0.5% | ± 0.5% | ± 0.5% |
| Input | | | |
| Measuring System Type | 1P2W, 1P3W, 3P3W, 3P4W | | |
| Voltage | 35 V _{AC} ~690 V _{AC} (L-L) 20 V _{AC} ~400 V _{AC} (L-N) | | |
| Current | 1A/5A | | |
| Frequency | 45~70Hz | | |
| Control Power | AC: 100~240V (max. power consumption 4.6W) DC: 100~300V | | |
| Data Record | | | |
| Max./Min. Value | ● | ● | ● |
| Alarm Status & Timestamp | ● | ● | ● |
| Alarm Counting | ● | ● | ● |
| Alarm Logs | | | |
| Data Logs | | | Fixed 4 parameters with configurable interval & duration (e.g. 4 parameters for 7 days at 1 minute intervals) |
| Customizable Data Logs | | | |
| Communication | | | |
| Protocol (Interface) | Modbus RTU (RS-485) | Modbus RTU (RS-485) | Modbus RTU (RS-485) |
| Mechanical Design | | | |
| IP Rating - Front Panel | IP52 | | |
| IP Rating - Case | IP20 | | |
| Dimensions (WxHxD, mm) | 72x72x107.7 | 96x96x95.4 | |
| Operating Environment | | | |
| Operating Temperature | -20 °C~+60 °C | -20 °C~+50 °C | |
| Storage Temperature | -30 °C~+70 °C | -30 °C~+60 °C | |
| Relative Humidity | ~ 95% RH | | |
| Altitude | Below 2,000 meters | | |
| Electromagnetic Compatibility | | | |
| Electrostatic Discharge | IEC 61000-4-2 | | |
| Immunity to Radiated Fields | IEC 61000-4-3 | | |
| Immunity to Fast Transients | IEC 61000-4-4 | | |
| Immunity to Impulse Waves | IEC 61000-4-5 | | |
| Conducted Immunity | IEC 61000-4-6 | | |
| Immunity to Magnetic Fields | IEC 61000-4-8 | | |
| Immunity to Voltage Dips | IEC 61000-4-11 | | |
| Radiated Emissions | FCC Part 15, EN 55011 Class A | | |
| Conducted Emissions | FCC Part 15, EN 55011 Class A | | |
| Harmonics Emissions | IEC 61000-3-2 | | |
| Flicker Emissions | IEC 61000-3-3 | | |
| Certification | | | |
| Safety | UL/CE | | |
| Accuracy | IEC 62053-22/CMA | | CMA |

Dimensions

DPM-C530
DPM-C520
DPM-C520W

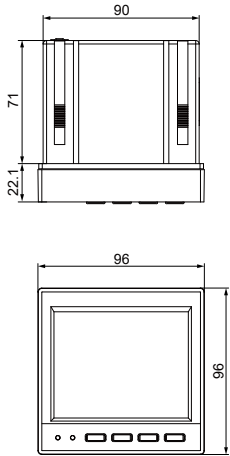

DPM-C530E

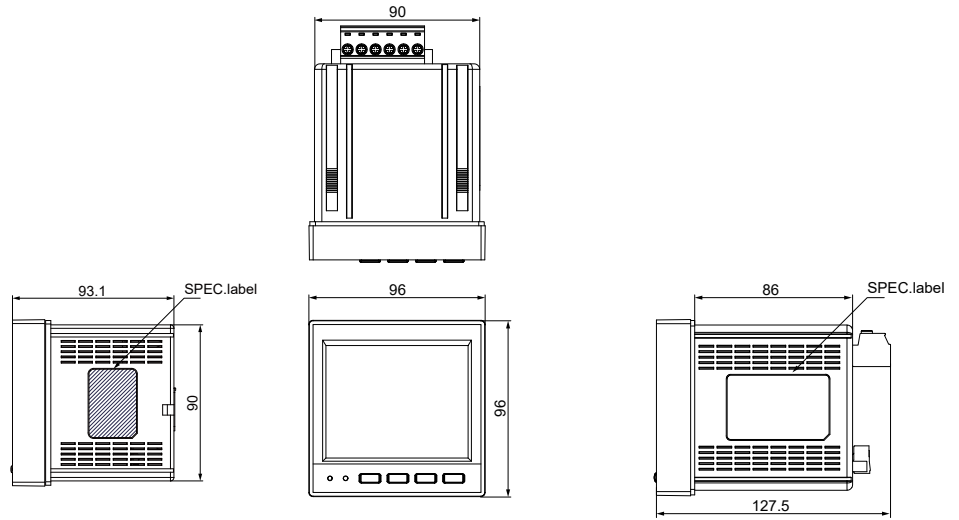

DPM-C501L
DPM-C502

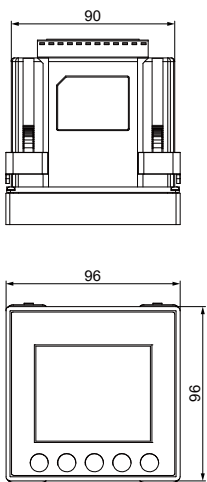

DPM-C320

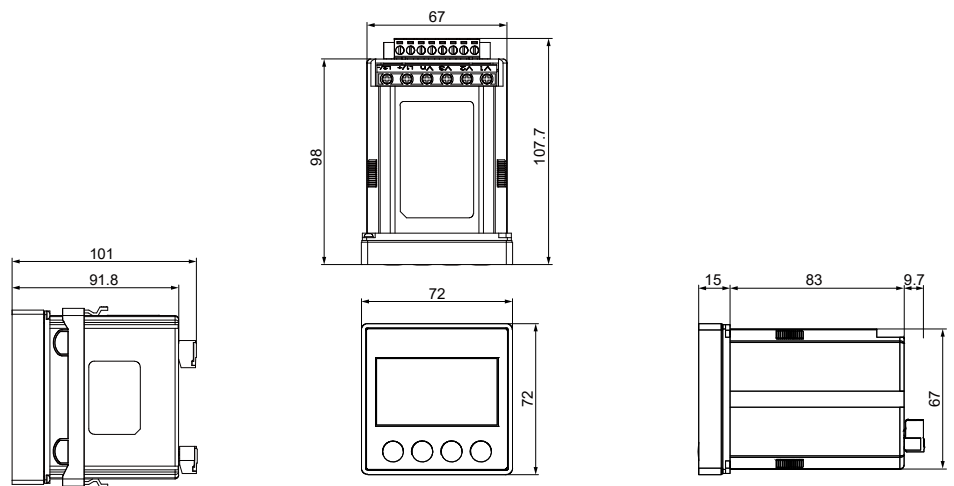

DIN Rail Mount Type DPM-D Series

- Easy installation and integration for various equipment
- Applicable to general energy management systems
- Multiple energy measurement functions for different applications

Applications

High power consuming equipment |
Electrical equipment cabinet | Enclosure



Features

Multi-Tariff

- Automatic measurement & calculation of power consumption during a specific time period
- Multiple interval groups setting to measure power consumption at different periods of time

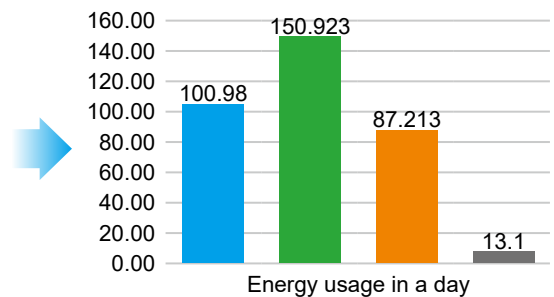
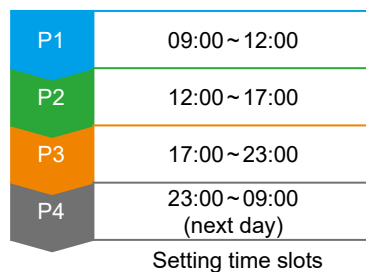

Pulse Output

- DPM-DA510/D530: Pulse output by active energy/reactive energy (import/export)
- Frequency divider: 1 ~ 9,999
- Pulse width: 0 ~ 5,000 ms (0 = 50% duty cycle)

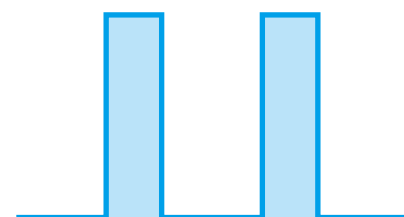

Pulse output 40 V_{DC}/50 mA
Per 0.1 kWh (default)

Data Recording

- User-defined time intervals for recording (Units: day/hour/min./sec.)
- Max. 50 parameters recording
- Max. 16 alarm conditions and max. 16 alarms recording

Recorded items vs. Record duration (at 1 minute intervals)

| Parameter(s) | Recording Days |
|--------------|----------------|
| 1 | 90 |
| 7 | 30 |
| 20 | 12 |

Demand Calculation

- Defines time intervals (default: 15 mins.)
- Demand calculation methods: Sliding block/fixed block
- Calculates the max. demand value/time in each tariff period

Sliding Block

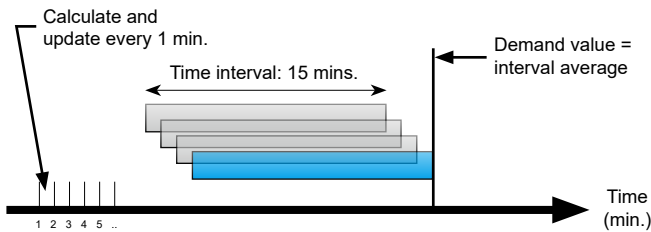

Fixed Block

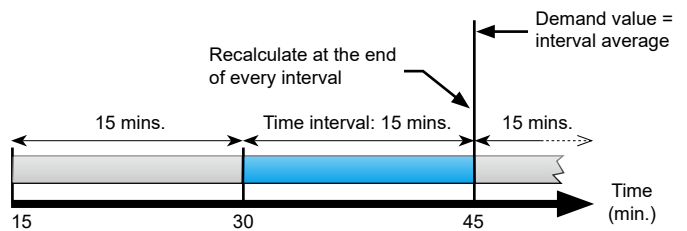

Automatic Wiring Correction (DPM-DA530)

- Automatic wiring correction via algorithm to save manpower for on-site re-wiring
- Fixes phase wiring errors and adjusts power flow direction

* Refer to product manual for function restrictions

Operation Process

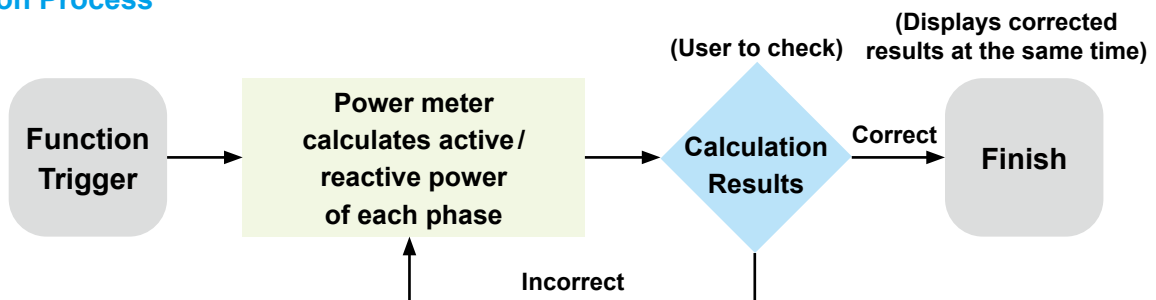

DPM-D Series Information

| Model | DPM-D520I | DPM-DA530 | DPM-DA510 |
|-----------------------------------------------|-----------------------------------------------------------------------------------|------------------------------------------------------------------------------------|-------------------------------------------------------------------------------------|
| Product Appearance |  |  |  |
| Accuracy Class | | | |
| Active Energy (IEC 62053-22) | 0.5% | 0.5% | 0.5% |
| Instantaneous Measurement | | | |
| Current | ● | ● | ● |
| Voltage | ● | ● | ● |
| Frequency | ● | ● | ● |
| Active, Reactive and Apparent Power | ● | ● | ● |
| Power Factor | ● | ● | ● |
| Active, Reactive and Apparent Energy | ● | ● | ● |
| Phasor Diagram (Current/Voltage) | | ● | ● |
| Demand Value | | | |
| Current | ● | ● | |
| Power | ● | ● | |
| Calculation Mode | Fixed Block | Sliding Block/Fixed Block | |
| Power Quality Analysis | | | |
| Current/Voltage Unbalance | ● | ● | |
| Total Harmonic Distortion (Current/Voltage) | ● | ● | |
| Individual Current/Voltage Harmonics | 31 st | | |
| Advanced Function | | | |
| Max./Min. Instantaneous Values with Timestamp | ● | ● | |
| Alarm Function | ● | ● | |
| Alarm Condition | 29 | 16 | |
| Alarm Logs | ● | ● | |
| Data Logs | ● | ● | |
| User-defined Modbus Address | 35 | 20 | |
| Monthly Energy Usage | ● | | |
| Multi-Tariff (Section number) | 8 | 8 | |
| Auto Wiring Correction | | ● | |
| CO ₂ Emission | | ● | |
| I/O | | | |
| Pulse Output | | 1 | 1 |
| Communication | | | |
| RS-485 | ● | ● | ● |
| Modbus | RTU/ASCII | RTU | RTU |

Technical Specifications

| Model | DPM-D520I | DPM-DA530 | DPM-DA510 |
|--------------------------------------|------------------------------------------------------------------------------------------------------------------|-----------------------------------------------------------------------------------------------------------------|---------------------|
| Measurement Accuracy | | | |
| Current | ± 0.5% | ± 0.5% | ± 0.5% |
| Voltage | ± 0.5% | ± 0.5% | ± 0.5% |
| Active Energy | ± 0.5% | ± 0.5% | ± 0.5% |
| Reactive Energy | ± 1% | ± 2% | ± 2% |
| Apparent Energy | ± 2% | ± 2% | ± 2% |
| Active Power | ± 0.5% | ± 0.5% | ± 0.5% |
| Reactive Power | ± 1% | ± 2% | ± 2% |
| Apparent Power | ± 2% | ± 2% | ± 2% |
| Power Factor | ± 0.5% | ± 0.5% | ± 0.5% |
| Frequency | ± 0.5% | ± 0.5% | ± 0.5% |
| Input | | | |
| Measuring System Type | 1P2W, 1P3W, 3P3W, 3P4W | | |
| Voltage | 35 V _{AC} ~690 V _{AC} (L-L) 20 V _{AC} ~400 V _{AC} (L-N) | 35 V _{AC} ~600 V _{AC} (L-L) 20 V _{AC} ~350 V _{AC} (L-N) | |
| Current | 63A | 1A/5A | |
| Frequency | 45~70 Hz | 45~65 Hz | |
| Control Power | AC: 80~265 V (Max. Power Consumption 4.6 W) DC: 100~300V | AC: 100~240 V (Max. Power Consumption 3W) DC: 100~250V | |
| Data Record | | | |
| Max./Min. Value | ● | ● | |
| Alarm Status & Timestamp | ● | ● | |
| Alarm Counting | ● | ● | |
| Alarm Logs | 500 | 16 | |
| Data Logs | Up to 17 parameters with configurable interval & duration (e.g. 17 parameters for 30 days at 1 minute intervals) | Up to 50 parameters with configurable interval & duration (e.g. 7 parameters for 30 days at 1 minute intervals) | |
| Customizable Data Logs | ● | ● | |
| Communication | | | |
| Protocol (Interface) | Modbus RTU/ASCII (RS-485) | Modbus RTU (RS-485) | Modbus RTU (RS-485) |
| Mechanical Design | | | |
| IP Rating - Case | IP20 | IP20 | |
| Dimensions (WxHxD, mm) | 126x90x67.4 | 72x87.5x58.7 | |
| Operating Environment | | | |
| Operating Temperature | -20°C~+60°C | 0°C~+60°C | |
| Storage Temperature | -30°C~+70°C | -10°C~+70°C | |
| Relative Humidity | | ~95% RH | |
| Altitude | | Below 2,000 meters | |
| Electromagnetic Compatibility | | | |
| Electrostatic Discharge | | IEC 61000-4-2 | |
| Immunity to Radiated Fields | | IEC 61000-4-3 | |
| Immunity to Fast Transients | | IEC 61000-4-4 | |
| Immunity to Impulse Waves | | IEC 61000-4-5 | |
| Conducted Immunity | | IEC 61000-4-6 | |
| Immunity to Magnetic Fields | | IEC 61000-4-8 | |
| Immunity to Voltage Dips | | IEC 61000-4-11 | |
| Radiated Emissions | | FCC Part 15, EN 55011 Class A | |
| Conducted Emissions | | FCC Part 15, EN 55011 Class A | |
| Harmonics Emissions | | IEC 61000-3-2 | |
| Flicker Emissions | | IEC 61000-3-3 | |
| Certification | | | |
| Safety | CE/RCM | CE | |
| Accuracy | CMA | | |

Dimensions

DPM-DA530
DPM-DA510

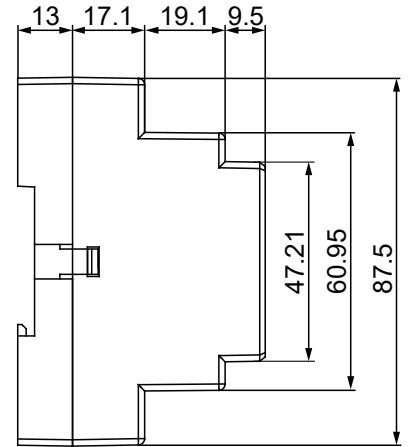
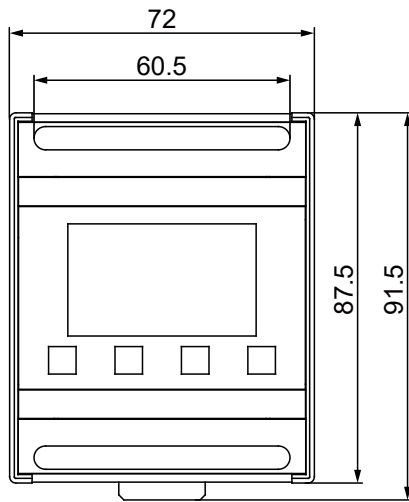
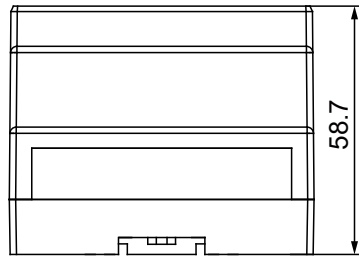

DPM-D520I

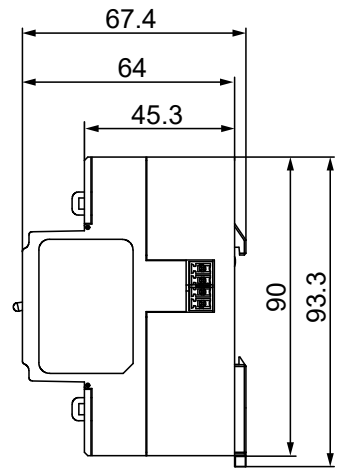
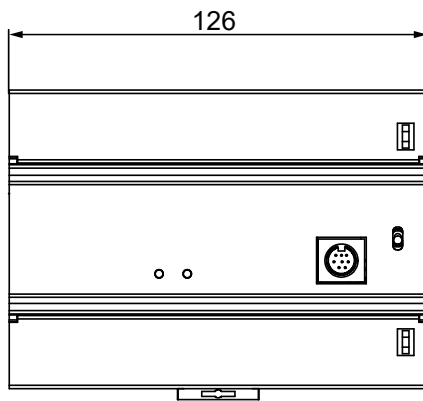

Multi-loop Type DPM-M Series

- Multiple and selective circuit monitoring reduces the use of power meters in large-scale areas
- Suitable for applications with lots of power circuits to save cost
- AC/DC measurement

Applications

Shopping mall | Dormitory | Telecommunication System



Features

Scalable Multi-Loop Configuration (DPM-MA3222)

- Dual main circuits with isolation for connection to different power systems
- Each main circuit connects 4 subcircuits; configures a total of 8 circuits (three-phase) or 24 circuits (single-phase)
- Subcircuit can be set to three-phase, single-phase, or three-phase & single-phase modes

Multi-loop
AC Power Meter
DPM-MA3222

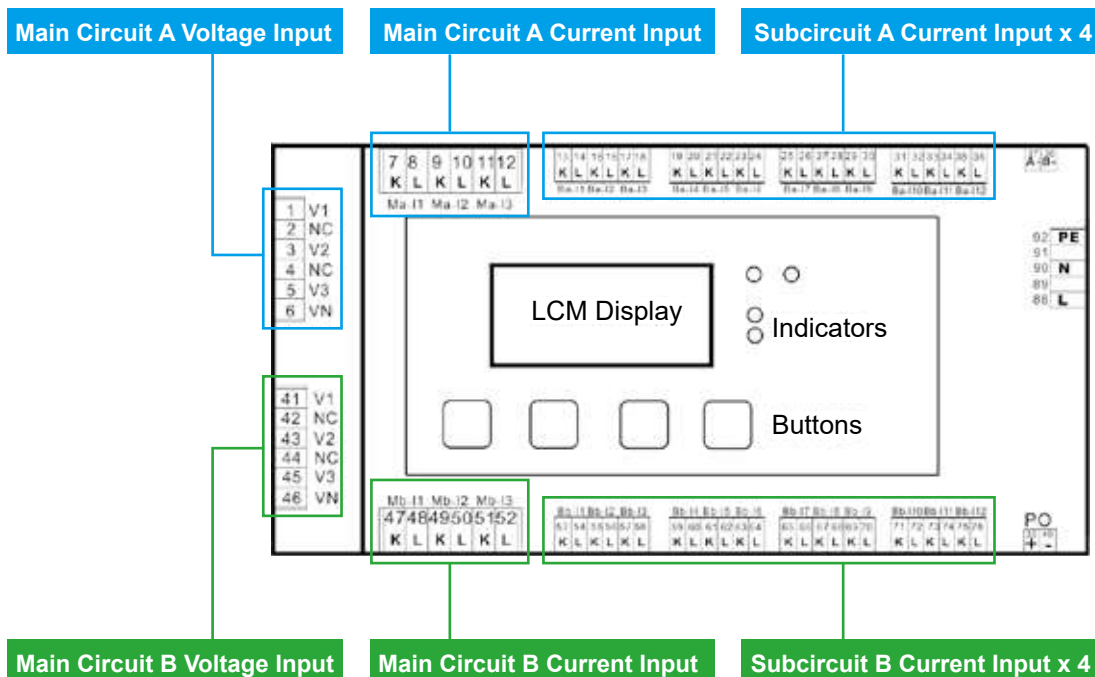

I/O Configuration (DPM-MA3222)

- Various I/O types for control and integration with peripheral devices



| I/O Type | Qty. | Functions |
|--------------------|------|--------------------------------------------------------------------------------------------------------------------------------------------------------------------------------------|
| Relay Output (RO) | 4 | <ul style="list-style-type: none"> • 5A/250V_{AC}, 5A/30V_{DC} • Alarm linkage: Hi/Lo/Hi hold/Lo hold |
| Digital Input (DI) | 2 | <ul style="list-style-type: none"> • Demand calculation trigger/stop • Record clearing: demand, max. demand, energy, max./min. value • Relay homing |
| Pulse Output (PO) | 1 | <ul style="list-style-type: none"> • 30V_{DC}, 30mA • Active/Reactive power output of any circuit |

Multi-Loop DC Measurement (DPM-MA1121)

- Supports max. 5 DC circuits
- Suitable for telecommunication, green energy, energy storage applications
- Dedicated power supply for Hall sensor (optional)

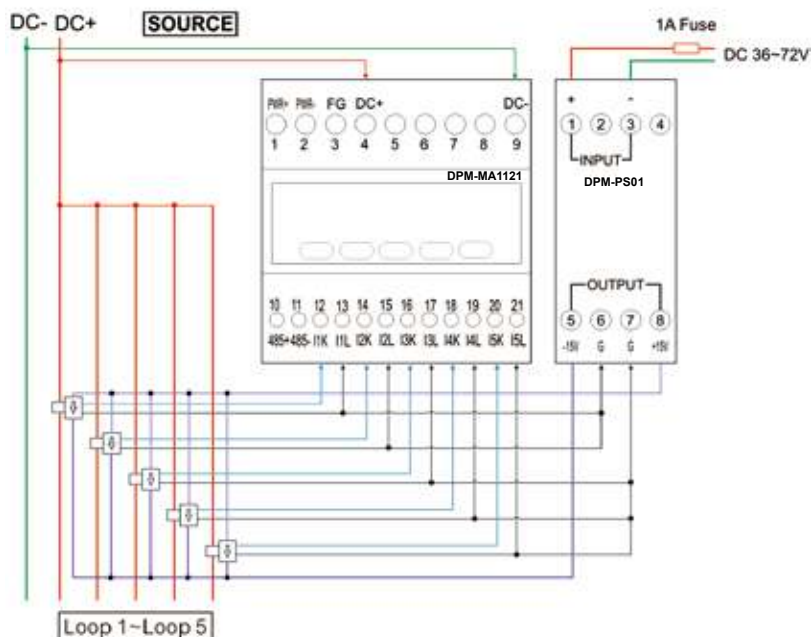

Multi-loop DC Power Meter DPM-MA1121



Hall Current Transformer (CT) Power Supply DPM-PS01



- Input voltage: 36~72V_{DC}
- Output voltage: ±15V_{DC}
- Output current: ±100mA

DPM-M Series Information

| Model | DPM-MA3222 | DPM-MA1121 |
|-----------------------------------------------|-----------------------------------------------------------------------------------|-------------------------------------------------------------------------------------|
| Product Appearance |  |  |
| Accuracy Class | | |
| Active Energy | 0.5% | 0.5% |
| Circuit Qty. | | |
| 3-Phase Measurement | 8 | |
| Single-Phase Measurement | 24 | 5 |
| Instantaneous Measurement | | |
| Current | ● | ● |
| Voltage | ● | ● |
| Frequency | ● | |
| Active power | ● | ● |
| Reactive and Apparent Power | ● | |
| Power Factor | ● | |
| Active Energy | ● | ● |
| Reactive and Apparent Energy | ● | |
| Demand Value | | |
| Current | ● | |
| Power | ● | |
| Calculation Mode | Sliding Block/Fixed Block | |
| Power Quality Analysis | | |
| Current/Voltage Unbalance | ● | |
| Total Harmonic Distortion (Current/Voltage) | ● | |
| Individual Current/Voltage Harmonics | 31 st | |
| Advanced Function | | |
| Max./Min. Instantaneous Values with Timestamp | ● | |
| Alarm Function | ● | |
| Alarm Condition | 48 | |
| Data Logs | ● | ● |
| User-defined Modbus Address | 80 | 20 |
| I/O | | |
| Digital Input | 2 | |
| Relay | 4 | |
| Pulse Output | 1 | |
| Communication | | |
| RS-485 | ● | ● |
| Modbus | RTU | RTU |

Technical Specifications

| Model | DPM-MA3222 | DPM-MA1121 |
|--------------------------------------|--------------------------------------------------------------------------------------------------------------------|--------------------------------------------------------------------------------------------------------------------|
| Measurement Accuracy | | |
| Current | ± 0.5% | ± 0.5% |
| Voltage | ± 0.5% | ± 0.5% |
| Active Energy | ± 0.5% | ± 0.5% |
| Reactive Energy | ± 2% | N/A |
| Apparent Energy | ± 2% | N/A |
| Active Power | ± 0.5% | ± 0.5% |
| Reactive Power | ± 2% | N/A |
| Apparent Power | ± 2% | N/A |
| Power Factor | ± 0.5% | N/A |
| Frequency | ± 0.5% | N/A |
| Input | | |
| Measuring System Type | 1P2W, 1P3W, 3P3W, 3P4W | 1P2W |
| Voltage | 35 V _{AC} ~ 600 V _{AC} (L-L) 20 V _{AC} ~ 400 V _{AC} (L-N) | ≤ 100 V _{DC} |
| Current | Main: 5A Subcircuit: 333 mV | ± 4 V _{DC} (Hall CT) |
| Frequency | 45 ~ 65 Hz | |
| Control Power | AC: 100 ~ 240V (max. power consumption 15W) DC: 100 ~ 250V | DC: 20 ~ 56V (max. power consumption 4W) |
| Data Record | | |
| Max. / Min. Value | ● | |
| Data Logs | Up to 86 parameters with configurable interval & duration (e.g. 40 parameters for 7 days at 1 minute Intervals) | Up to 21 parameters with configurable interval & duration (e.g. 20 parameters for 6 days at 1 minute Intervals) |
| Customizable Data Logs | ● | ● |
| Communication | | |
| Protocol (Interface) | Modbus RTU (RS-485) | Modbus RTU (RS-485) |
| Mechanical Design | | |
| IP Rating - Case | IP20 | |
| Dimensions (WxHxD, mm) | 199x118x77 | 54x81x65.5 |
| Operating Environment | | |
| Operating Temperature | 0°C ~ +60°C | |
| Storage Temperature | -10°C ~ +70°C | |
| Relative Humidity | ~ 95% RH | |
| Altitude | Below 2,000 meters | |
| Electromagnetic Compatibility | | |
| Electrostatic Discharge | IEC 61000-4-2 | |
| Immunity to Radiated Fields | IEC 61000-4-3 | |
| Immunity to Fast Transients | IEC 61000-4-4 | |
| Immunity to Impulse Waves | IEC 61000-4-5 | |
| Conducted Immunity | IEC 61000-4-6 | |
| Immunity to Magnetic Fields | IEC 61000-4-8 | |
| Immunity to Voltage Dips | IEC 61000-4-11 | |
| Radiated Emissions | FCC Part 15, EN 55011 Class A | |
| Conducted Emissions | FCC Part 15, EN 55011 Class A | |
| Harmonics Emissions | IEC 61000-3-2 | |
| Flicker Emissions | IEC 61000-3-3 | |
| Certification | | |
| Safety | CE | |

Dimensions

DPM-MA3222

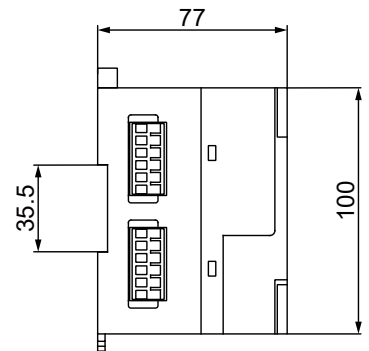
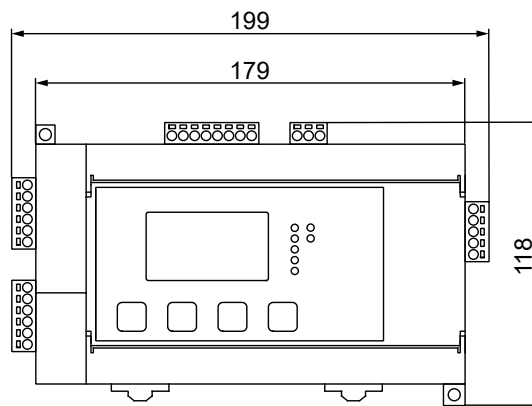
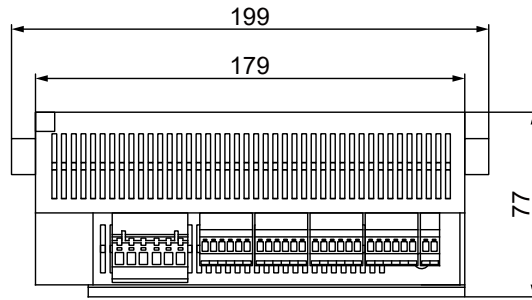

DPM-MA1121

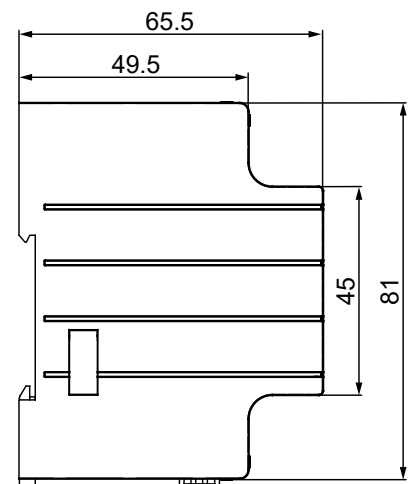
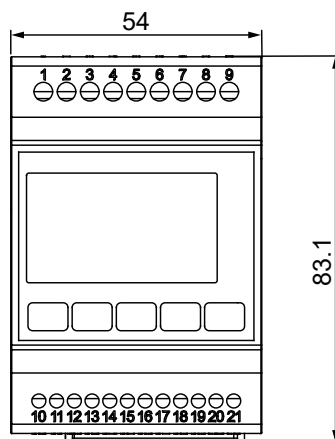
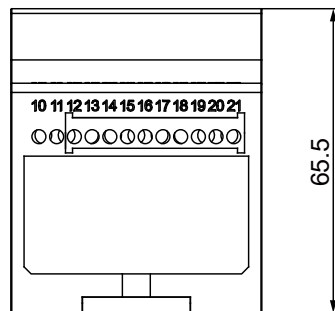



Current Transformer (CT)

- Accessories for current measurement, suitable for all types of power meters
- Proportionally transforms high circuit current into low current (or low voltage) signals for current measurement

Applications

Matches with all types of power meters to transform high current into measurable low current (voltage)

Product Information (Refer to Ordering Information for more details)

| Type | Model | Features |
|---------------------------------------------------------------------------------------------------------------------|---------------|-------------------------------------------------------------------------------------------------------------------------------------------------------------------|
| Solid Core CT  | DCT-MC | <ul style="list-style-type: none"> • Installation through the CT core • Applicable to new system configuration |
| Compact Split Core CT  | DCT-CS | <ul style="list-style-type: none"> • Compact size, easy to install/dismantle by opening the split top • Suitable for various applications |
| | DCT-MV | |
| Split Core CT  | DCT-S | <ul style="list-style-type: none"> • Easy to install/dismantle by opening the split top • Complies with safety certifications |

Ordering Information

Panel Mount Type Power Meter

| Model | Functions (Refer to Technical Specs. for details) | Front Panel Dimensions (mm) | Current Measurement | Communication | Certifications |
|-----------|------------------------------------------------------------------------------------------------------------------------------------------------------------------------------------------------------------------------------|--------------------------------|---------------------------------------------|------------------------------|----------------|
| DPM-C530 | <ul style="list-style-type: none"> Electrical parameters measurement (Active energy accuracy Class 0.5S) Multi-tariff power measurement | 96 x 96 | Through external CT (secondary side): 1A/5A | RS-485 (Modbus/BACNet MS/TP) | CE/UL/RCM |
| DPM-C530E | <ul style="list-style-type: none"> Demand value calculation Data recording Harmonics measurement | | | Ethernet x2 (Modbus) | CE/UL |
| DPM-C502 | <ul style="list-style-type: none"> Electrical parameters measurement (Active energy accuracy 0.5%) 4 DI/2 DO Other functions are similar to DPM-C530, refer to Technical Specs. for details | | | RS-485 (Modbus) | |
| DPM-C520 | <ul style="list-style-type: none"> Electrical parameters measurement (Active energy accuracy Class 0.5S) Harmonics measurement | 96 x 96 | | RS-485 (Modbus) | CE/UL |
| DPM-C520W | | | | Wifi (802.11 b/g/n) | |
| DPM-C320 | | 72 x 72 | | RS-485 (Modbus) | |
| DPM-C501L | <ul style="list-style-type: none"> Electrical parameters measurement (Active energy accuracy 0.5%) Harmonics measurement 4 DI/2 DO | 96 x 96 | | RS-485 (Modbus) | |

DIN Rail Mount Type Power Meter

| Model | Functions (Refer to Technical Specs. for details) | Current Measurement | Communication | Certifications |
|-----------|-------------------------------------------------------------------------------------------------------------------------------------------------------------------------|---------------------------------------------|-----------------|----------------|
| DPM-D520I | <ul style="list-style-type: none"> Electrical parameters measurement (Active energy accuracy 0.5%) Multi-tariff power measurement | Direct measurement: 63A | RS-485 (Modbus) | CE |
| DPM-DA530 | <ul style="list-style-type: none"> Demand value calculation Data recording Harmonics measurement Pulse output x 1 (DPM-DA530) | Through external CT (secondary side): 1A/5A | | |
| DPM-DA510 | <ul style="list-style-type: none"> Electrical parameters measurement (Active energy accuracy 0.5%) Pulse output x 1 | | | |

Multi-Loop Type Power Meter

| Model | Functions (Refer to Technical Specs. for details) | Current Measurement | Communication | Certifications |
|------------|--------------------------------------------------------------------------------------------------------------------------------------------------------------------------------------------------------------------------------------------------------------|------------------------------------------------------------------------------------------------------------------------------------------------------|-----------------|----------------|
| DPM-MA3222 | <ul style="list-style-type: none"> AC electrical parameters measurement (Active energy accuracy 0.5%) Circuit qty.: 8 (three-phase)/24 (single-phase) Data recording Harmonics measurement 2 DI/4 RO/1 PO | Through external CT <ul style="list-style-type: none"> Main circuit: 5A (secondary side) Subcircuit: 333 mV (secondary side) | RS-485 (Modbus) | CE |
| DPM-MA1121 | <ul style="list-style-type: none"> DC electrical parameters measurement (Active energy accuracy 0.5%) Circuit qty.: 5 Data recording | Through Hall Sensor | | |

Solid Core CT

| Model | Certification | Primary Current | Secondary Current | Max. Load | Measurement Accuracy (PF=1) | Dimensions (Unit: mm) |
|-------------|---------------|-----------------|-------------------|-----------|-----------------------------|-----------------------------------|
| DCT-MC010-5 | - | 100A | 5A | 1.5VA | 1% | Outer: 80x60x38 Inner: 20x30.5 |
| DCT-MC020-5 | - | 200A | 5A | 3.75VA | 0.5% | |
| DCT-MC030-5 | - | 300A | 5A | 5VA | 0.5% | Outer: 98x74.5x43 Inner: 42x42 |
| DCT-MC040-5 | - | 400A | 5A | 7.5VA | 0.5% | |
| DCT-MC050-5 | - | 500A | 5A | 5VA | 0.5% | Outer: 127x103x45 Inner: 51x61 |
| DCT-MC060-5 | - | 600A | 5A | 10VA | 0.5% | |

Compact Split Core CT

| Model | Certification | Primary Current | Secondary Current | Wiring Length | Measurement Accuracy (PF=1) | Dimensions (Unit: mm) |
|-------------|---------------|-----------------|-------------------|---------------|-----------------------------|---------------------------------------------|
| DCT-CS010-5 | - | 100A | 5A | 1,000 mm | 1% | Outer: 66.8x49.8x34.2 Inner: 23.8x25.2 |
| DCT-CS020-5 | - | 200A | 5A | 1,000 mm | 1% | |
| DCT-CS030-5 | - | 300A | 5A | 1,000 mm | 1% | |
| DCT-CS040-5 | - | 400A | 5A | 1,000 mm | 1% | Outer: 85x69x42.5 Inner: 36.5x36.5 |
| DCT-CS050-5 | - | 500A | 5A | 1,000 mm | 1% | |
| DCT-CS060-5 | - | 600A | 5A | 1,000 mm | 1% | |
| DCT-MV005-3 | CE | 5A | 330 mV | 1,200 mm | 1% | Outer: 30.8x28.8x42.8 Inner: Φ 10.2 |
| DCT-MV060-3 | CE | 60A | | 1,200 mm | 0.5% | Outer: 30.3x33.9x49 Inner: Φ 16.1 |
| DCT-MV100-3 | CE | 100A | | 1,200 mm | 0.5% | Outer: 53.3x40.2x70 Inner: Φ 24.1 |
| DCT-MV200-3 | CE | 200A | | 1,200 mm | 0.5% | |
| DCT-MV300-3 | CE | 300A | | 1,200 mm | 0.5% | Outer: 67x42.8x83 Inner: Φ 24.1 |
| DCT-MV400-3 | CE | 400A | | 1,200 mm | 0.5% | |

Split Core CT

| Model | Certification | Primary Current | Secondary Current | Max. Load | Measurement Accuracy (PF=1) | Dimensions (Unit: mm) |
|-----------|---------------|-----------------|-------------------|-----------|-----------------------------|--------------------------------------|
| DCT-S201B | UL | 100A | 5A | 1.0 VA | 1.0% | Outer: 90x40x110 Inner: 30x20 |
| DCT-S211B | UL | 200A | 5A | 1.0 VA | 0.5% | |
| DCT-S221B | UL | 300A | 5A | 1.5 VA | 0.5% | |
| DCT-S231B | UL | 400A | 5A | 1.5 VA | 0.5% | Outer: 115x37x159 Inner: 80x50 |
| DCT-S241B | UL | 500A | 5A | 2.5 VA | 0.5% | |
| DCT-S251B | UL | 600A | 5A | 2.5 VA | 0.5% | |
| DCT-S261B | UL | 750A | 5A | 2.5 VA | 0.5% | |
| DCT-S2C1B | UL | 800A | 5A | 3.75 VA | 0.5% | |
| DCT-S271B | UL | 1,000A | 5A | 5 VA | 0.5% | |
| DCT-S301C | CE | 100A | 5A | 1.5VA | 1.0% | Outer: 89x40x115 Inner: 32x21 |
| DCT-S211C | CE | 200A | 5A | 1.0VA | 0.5% | |
| DCT-S221C | CE | 300A | 5A | 1.5 VA | 0.5% | |
| DCT-S231C | CE | 400A | 5A | 2.5 VA | 0.5% | |
| DCT-S241C | CE | 500A | 5A | 2.5 VA | 0.5% | Outer: 116x51x145 Inner: 80x50 |
| DCT-S251C | CE | 600A | 5A | 2.5 VA | 0.5% | |
| DCT-S261C | CE | 750A | 5A | 2.5 VA | 0.5% | |
| DCT-S271C | CE | 1,000A | 5A | 5 VA | 0.5% | |
| DCT-S281C | CE | 1,500A | 5A | 7.5 VA | 0.5% | Outer: 146x51.6x196 Inner: 80x122 |
| DCT-S291C | CE | 2,000A | 5A | 10 VA | 0.5% | Outer: 186x67x250 Inner: 81x160.5 |
| DCT-S2A1C | CE | 2,500A | 5A | 15 VA | 0.5% | |
| DCT-S2B1C | CE | 3,000A | 5A | 20 VA | 0.5% | |

Hall Sensor Power Supply

| Model | Input Voltage | | Output | | Ripple & Noise (mVp-p, Typ./Max.) | Efficiency (% , @ Full load) | Dimensions (mm) |
|----------|----------------------------------|-------------------------|----------------------------|-------------------------|-----------------------------------|------------------------------|-----------------|
| | Normal (V _{DC} , Range) | Max. (V _{DC}) | Voltage (V _{DC}) | Current (mA, Max./Min.) | | | |
| DPM-PS01 | 48 (36~72) | 80 | ±15 | ±100/±5 | 40/75 | 80 | 65.5x26x81 |

Global Operations

ASIA (Taiwan)



Taoyuan Technology Center (Green Building)



Taoyuan Plant 1



Tainan Plant (Diamond-rated Green Building)

ASIA (China)



Wujiang Plant 3



Shanghai Office



ASIA (Japan)



Tokyo Office

ASIA (India)



Rudrapur Plant
(Green Building)

EUROPE



Amsterdam, the Netherlands

AMERICA



Research Triangle Park, U.S.A.

▲ 6 Factories ■ 117 Branch Offices ● 13 R&D Centers ■ 915 Distributors

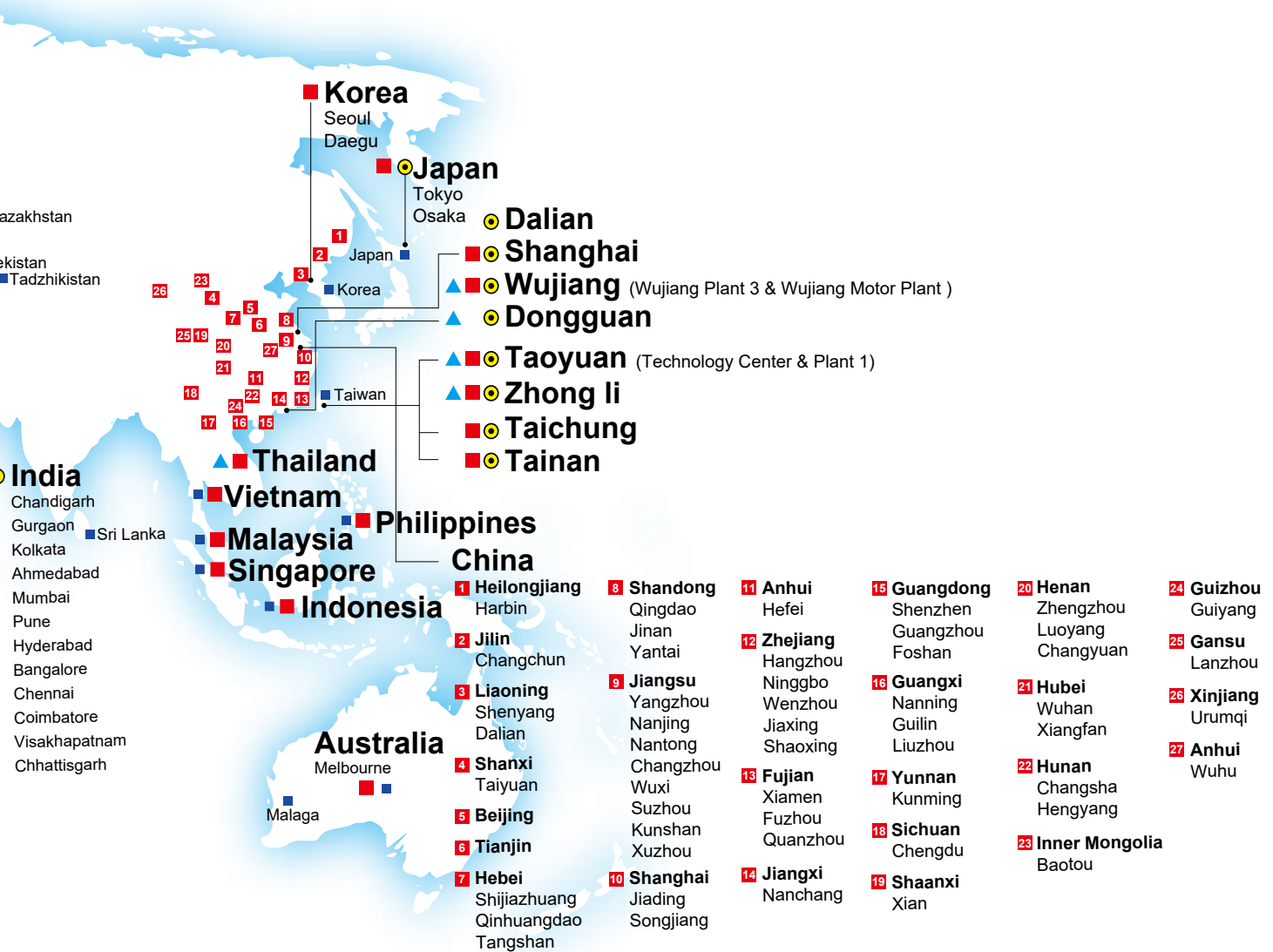



Smarter. Greener. Together.

Industrial Automation Headquarters

Delta Electronics, Inc.

Taoyuan Technology Center
No.18, Xinglong Rd., Taoyuan District,
Taoyuan City 33068, Taiwan
TEL: 886-3-362-6301 / FAX: 886-3-371-6301

Asia

Delta Electronics (Shanghai) Co., Ltd.

No.182 Minyu Rd., Pudong Shanghai, P.R.C.
Post code : 201209
TEL: 86-21-6872-3988 / FAX: 86-21-6872-3996
Customer Service: 400-820-9595

Delta Electronics (Japan), Inc.

Tokyo Office
Industrial Automation Sales Department
2-1-14 Shibadaimon, Minato-ku
Tokyo, Japan 105-0012
TEL: 81-3-5733-1155 / FAX: 81-3-5733-1255

Delta Electronics (Korea), Inc.

Seoul Office
1511, 219, Gasan Digital 1-Ro., Geumcheon-gu,
Seoul, 08501 South Korea
TEL: 82-2-515-5305 / FAX: 82-2-515-5302

Delta Energy Systems (Singapore) Pte Ltd.

4 Kaki Bukit Avenue 1, #05-04, Singapore 417939
TEL: 65-6747-5155 / FAX: 65-6744-9228

Delta Electronics (India) Pvt. Ltd.

Plot No.43, Sector 35, HSIIDC Gurgaon,
PIN 122001, Haryana, India
TEL: 91-124-4874900 / FAX : 91-124-4874945

Delta Electronics (Thailand) PCL.

909 Soi 9, Moo 4, Bangpoo Industrial Estate (E.P.Z),
Pattana 1 Rd., T.Phraksa, A.Muang,
Samutprakarn 10280, Thailand
TEL: 66-2709-2800 / FAX : 662-709-2827

Delta Electronics (Australia) Pty Ltd.

Unit 20-21/45 Normanby Rd., Notting Hill Vic 3168, Australia
TEL: 61-3-9543-3720

Americas

Delta Electronics (Americas) Ltd.

Raleigh Office
P.O. Box 12173, 5101 Davis Drive,
Research Triangle Park, NC 27709, U.S.A.
TEL: 1-919-767-3813 / FAX: 1-919-767-3969

Delta Electronics Brazil

São Paulo Sales Office
Rua Itapeva, 26 - 3º, andar Edifício Itapeva,
One - Bela Vista 01332-000 - São Paulo - SP - Brazil
TEL: 55-12-3932-2300 / FAX: 55-12-3932-237

Delta Electronics International Mexico S.A. de C.V.

Mexico Office
Gustavo Baz No. 309 Edificio E PB 103
Colonia La Loma, CP 54060
Tlalnepantla, Estado de México
TEL: 52-55-3603-9200

EMEA

Headquarters: Delta Electronics (Netherlands) B.V.

Sales: Sales.IA.EMEA@deltaww.com
Marketing: Marketing.IA.EMEA@deltaww.com
Technical Support: iatechnicalsupport@deltaww.com
Customer Support: Customer-Support@deltaww.com
Service: Service.IA.emea@deltaww.com
TEL: 31(0)40 800 3900

BENELUX: Delta Electronics (Netherlands) B.V.

De Witbogt 20, 5652 AG Eindhoven, The Netherlands
Mail: Sales.IA.Benelux@deltaww.com
TEL: 31(0)40 800 3900

DACH: Delta Electronics (Netherlands) B.V.

Coesterweg 45, D-59494 Soest, Germany
Mail: Sales.IA.DACH@deltaww.com
TEL: 49(0)2921 987 0

France: Delta Electronics (France) S.A.

ZI du bois Challand 2, 15 rue des Pyrénées,
Lisses, 91090 Evry Cedex, France
Mail: Sales.IA.FR@deltaww.com
TEL: 33(0)1 69 77 82 60

Iberia: Delta Electronics Solutions (Spain) S.L.U

Ctra. De Villaverde a Vallecas, 265 1º Dcha Ed.
Hormigueras – P.I. de Vallecas 28031 Madrid
TEL: 34(0)91 223 74 20

Carrer Llacuna 166, 08018 Barcelona, Spain

Mail: Sales.IA.Iberia@deltaww.com

Italy: Delta Electronics (Italy) S.r.l.

Via Meda 2-22060 Novedrate(CO)
Piazza Grazioli 18 00186 Roma Italy
Mail: Sales.IA.Italy@deltaww.com
TEL: 39 039 8900365

Russia: Delta Energy System LLC

Vereyskaya Plaza II, office 112 Vereyskaya str.
17 121357 Moscow Russia
Mail: Sales.IA.RU@deltaww.com
TEL: 7 495 644 3240

Turkey: Delta Greentech Elektronik San. Ltd. Sti. (Turkey)

Şerifaii Mah. Hendem Cad. Kule Sok. No:16-A
34775 Ümraniye – İstanbul
Mail: Sales.IA.Turkey@deltaww.com
TEL: 90 216 499 9910

GCC: Delta Energy Systems AG (Dubai BR)

P.O. Box 185668, Gate 7, 3rd Floor, Hamarain Centre
Dubai, United Arab Emirates
Mail: Sales.IA.MEA@deltaww.com
TEL: 971(0)4 2690148

Egypt + North Africa: Delta Electronics

Unit 318, 3rd Floor, Trivium Business Complex, North 90 street,
New Cairo, Cairo, Egypt
Mail: Sales.IA.MEA@deltaww.com